

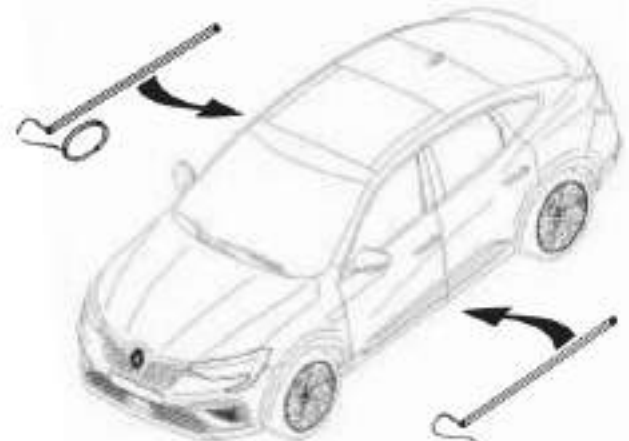

# ARKANA

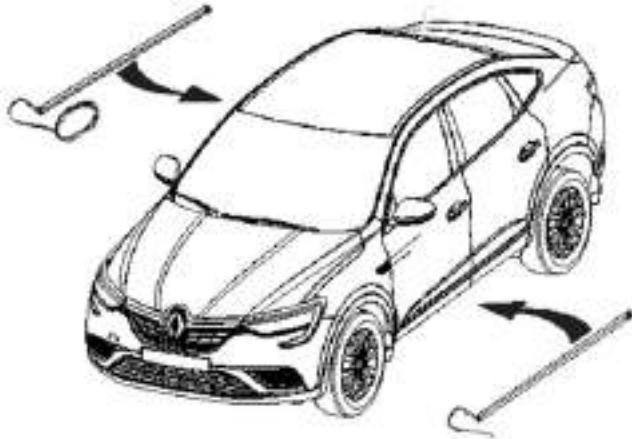

26 66 889 29R



E11

E11\*10R05/01\*10581\*01

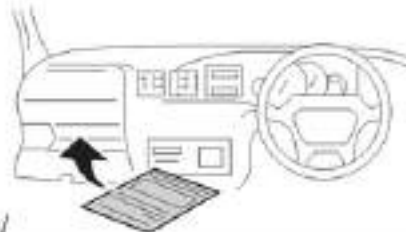
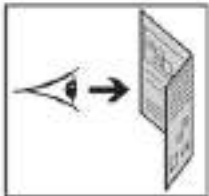

[www.tech-accessoires.renault.com/](http://www.tech-accessoires.renault.com/)

FRA Instructions de montage

CEŠokyny pro montáž

DNMonteringsveiledning

DEEinbauanleitung

ENG Installation instructions

SPInstrucciones de montaje

ESTPaigaldusjuhised

FINAsennusohje

ELL Οδηγες συναρμολόγησης

HRWávodový k montáži

HUÉpítési utasítások

ITA Istruzioni per il montaggio

JPN 取付説明書

KOR 조립설명서

LIT Montavimo instrukcija

LAV Montāšanas instrukcijas

NLDInbouwhandleiding

NOR Monteringsveiledning

POInstrukcja wbudowania

POR Instruções de montagem

RON Instrucțiuni de montaj

RUS Инструкция по монтажу

SLK Návod na zabudovanie

SLWVodila za inštalacijo

SWMontageanvisning

TUMontaj talimatları

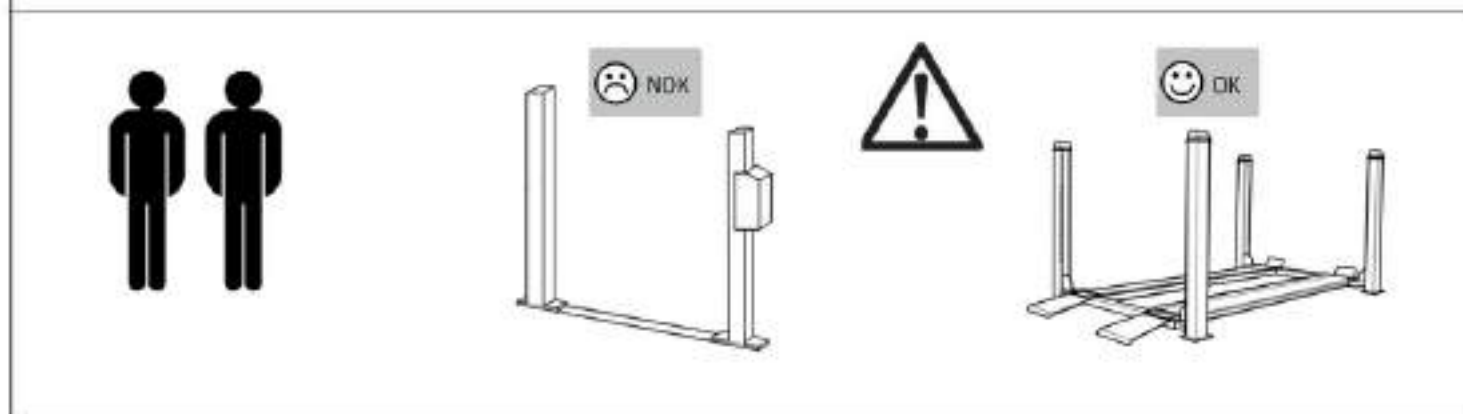
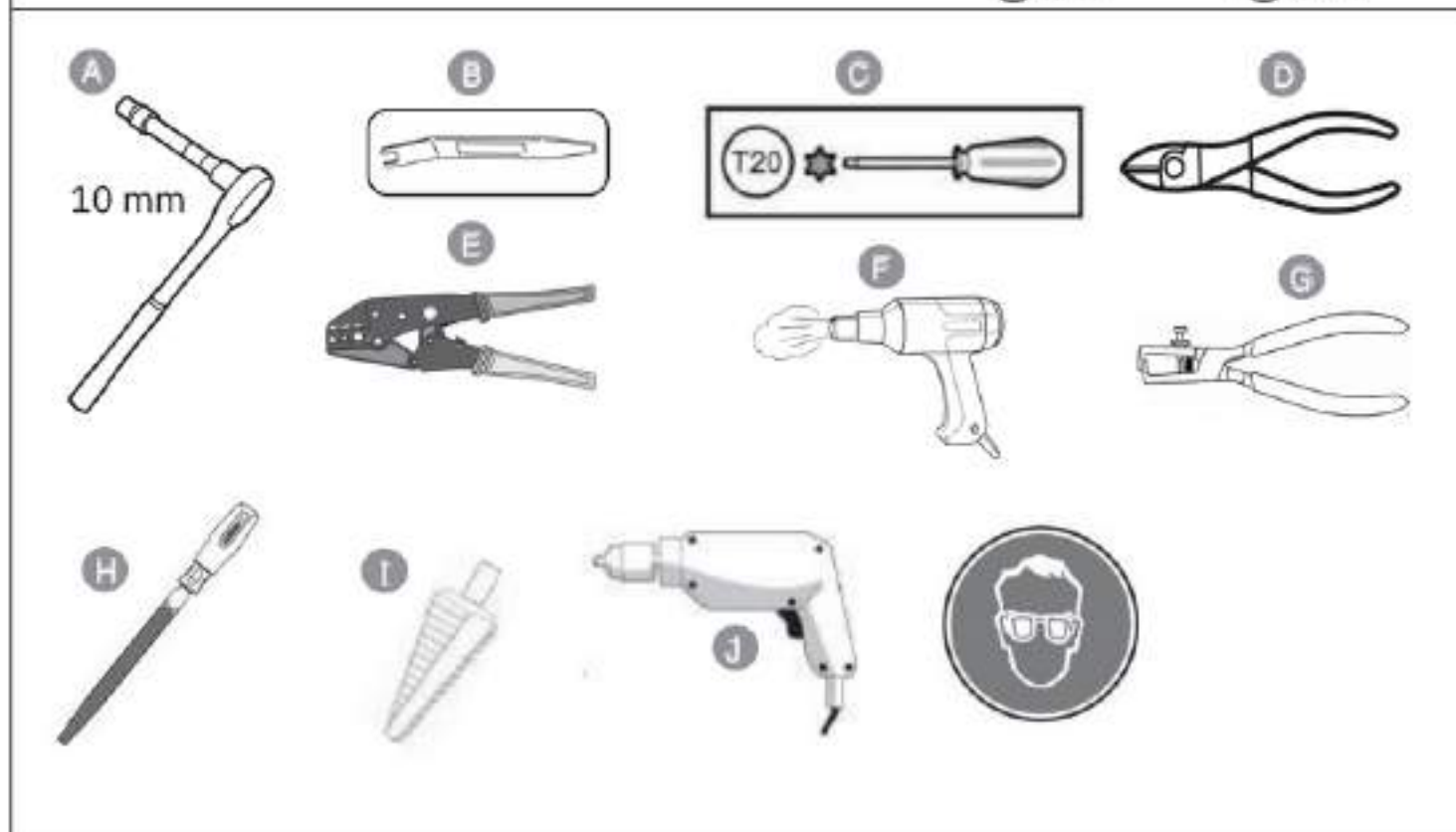
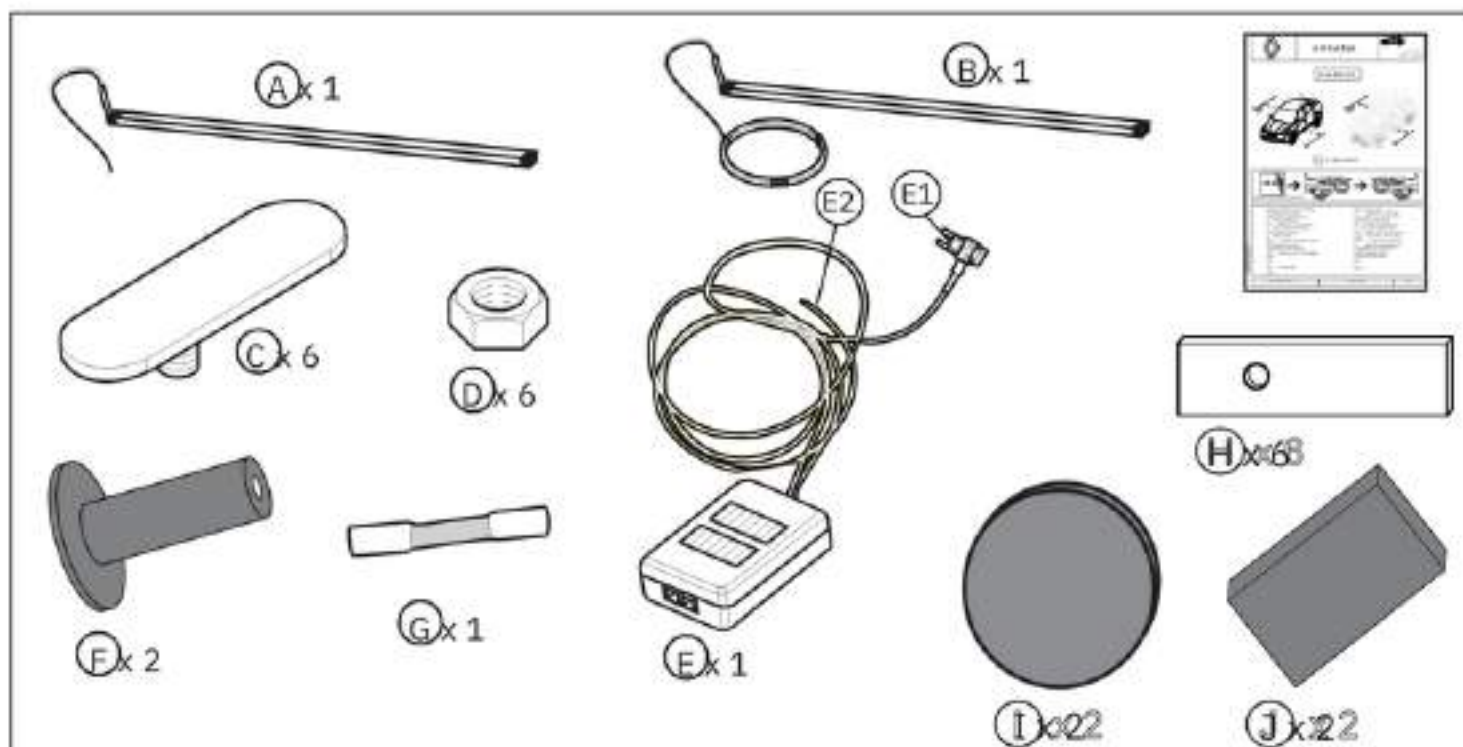

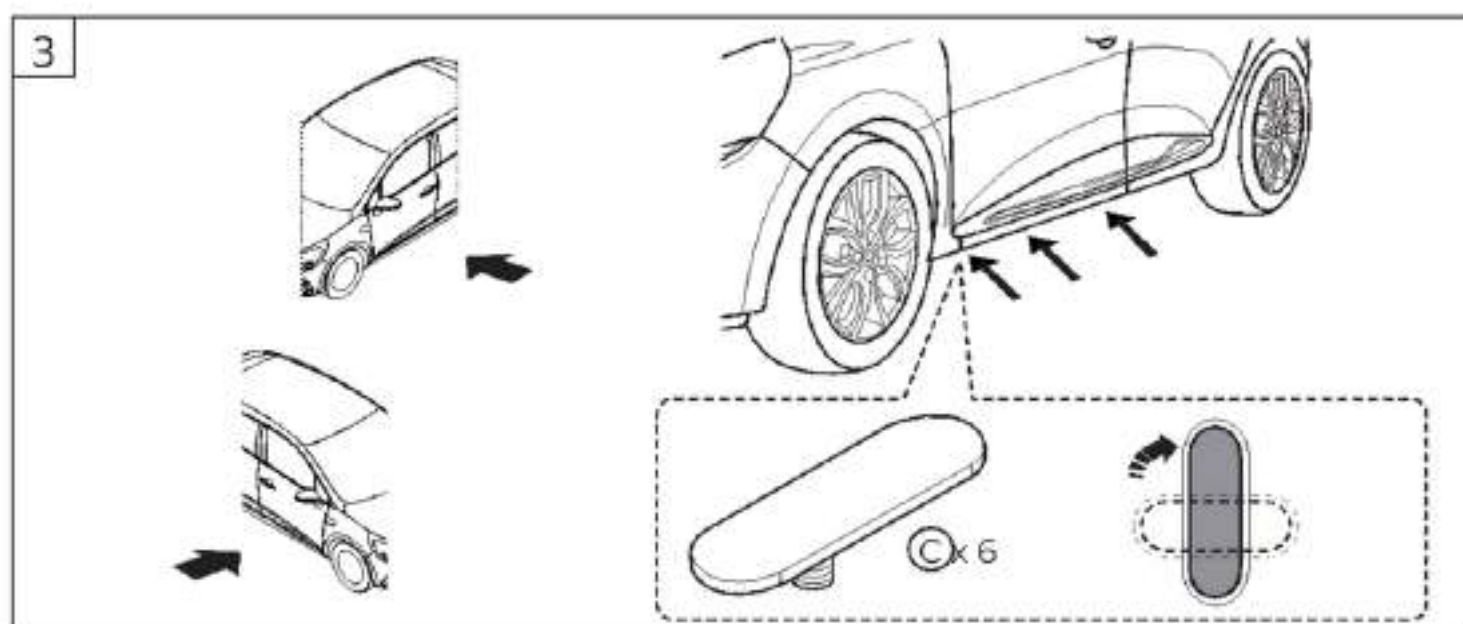
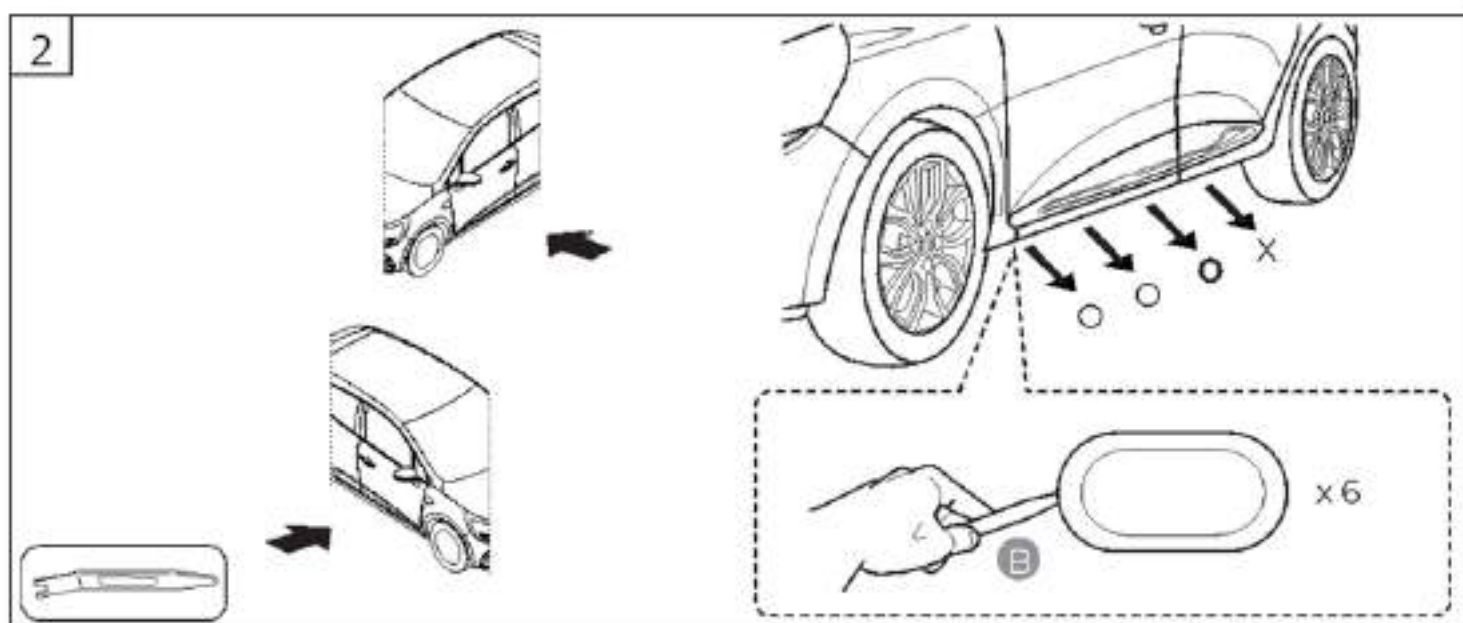
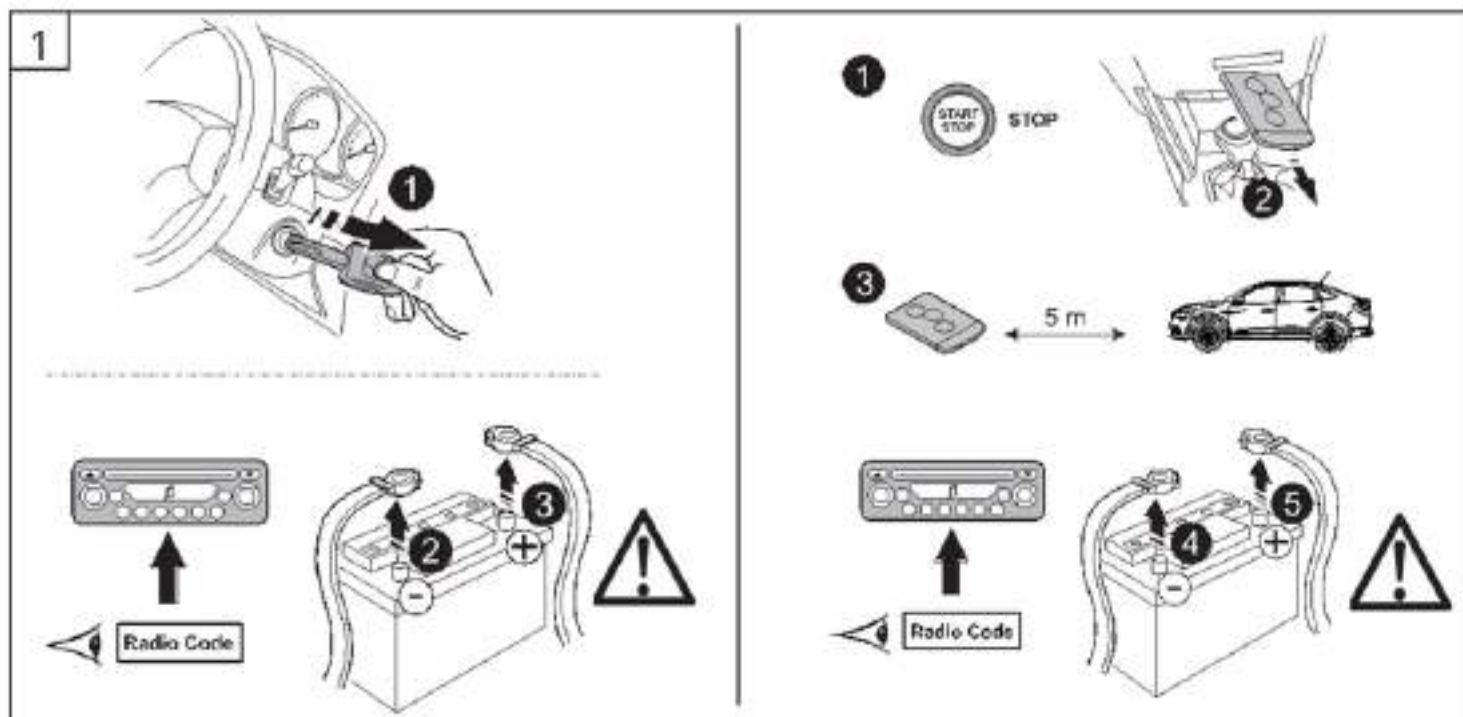

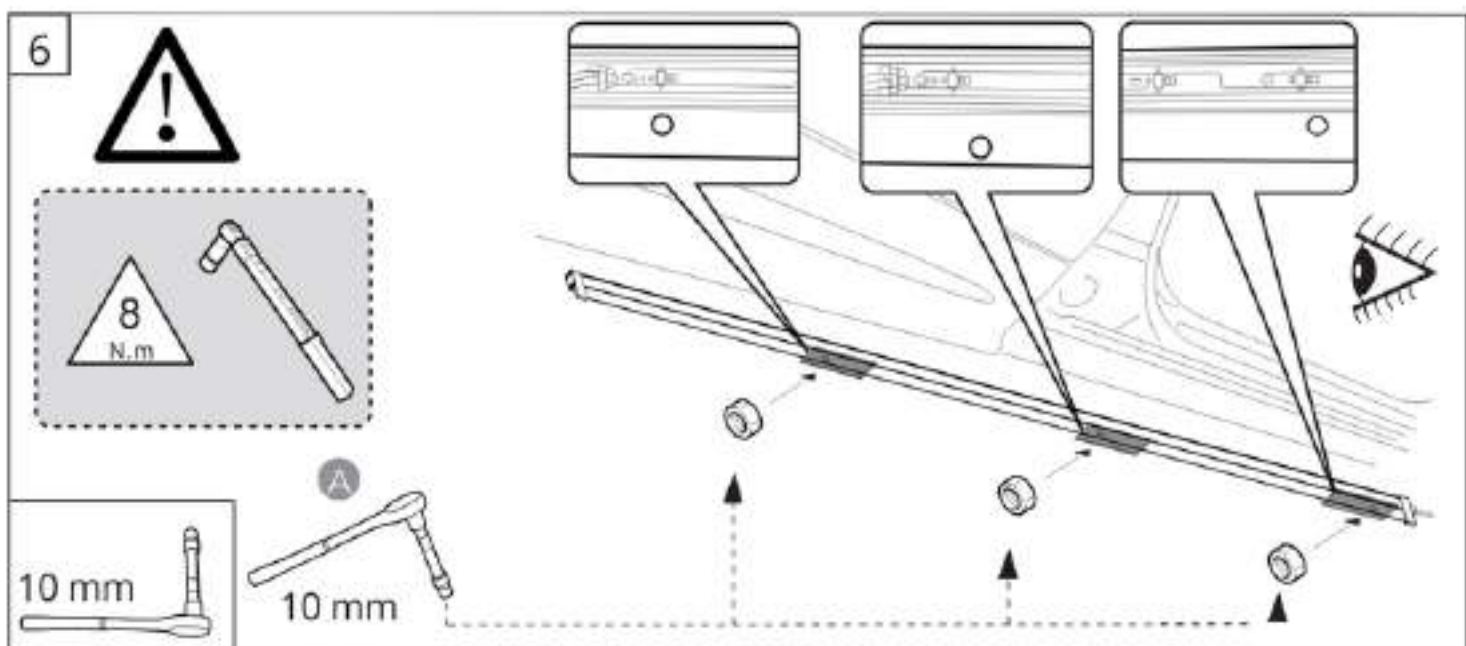
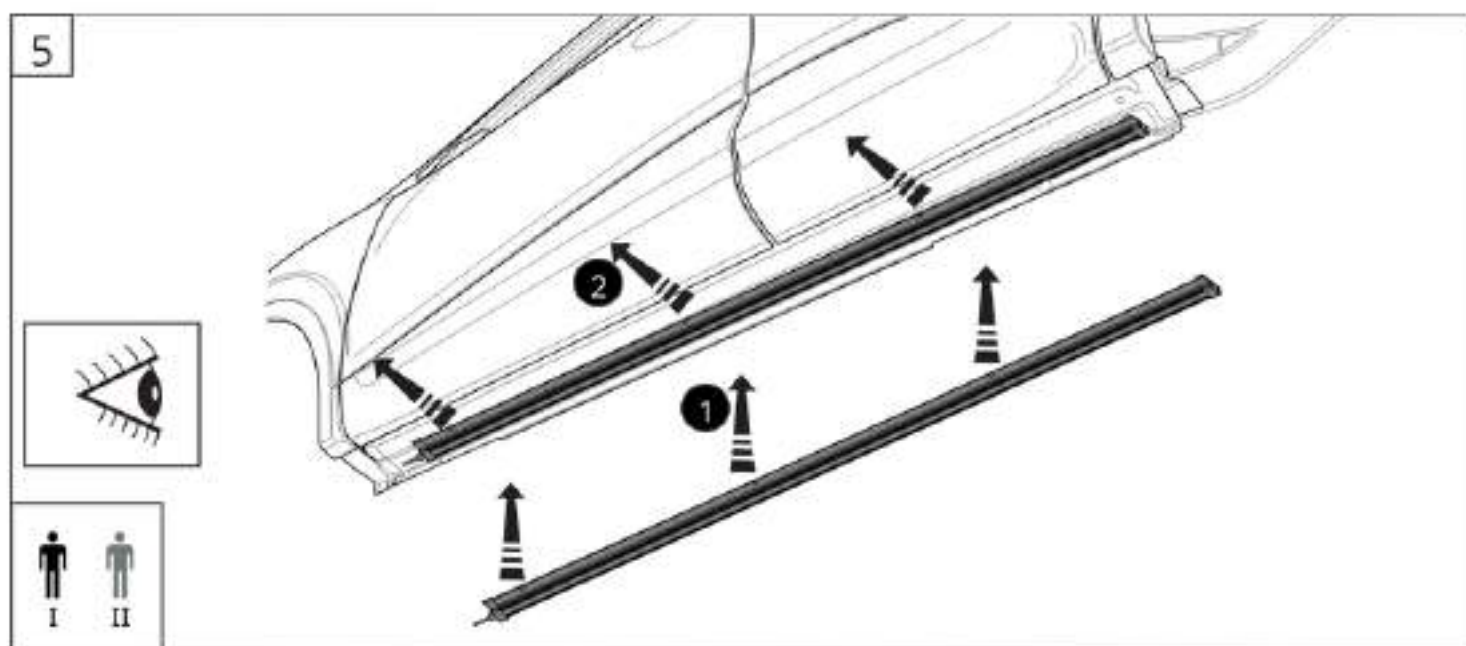
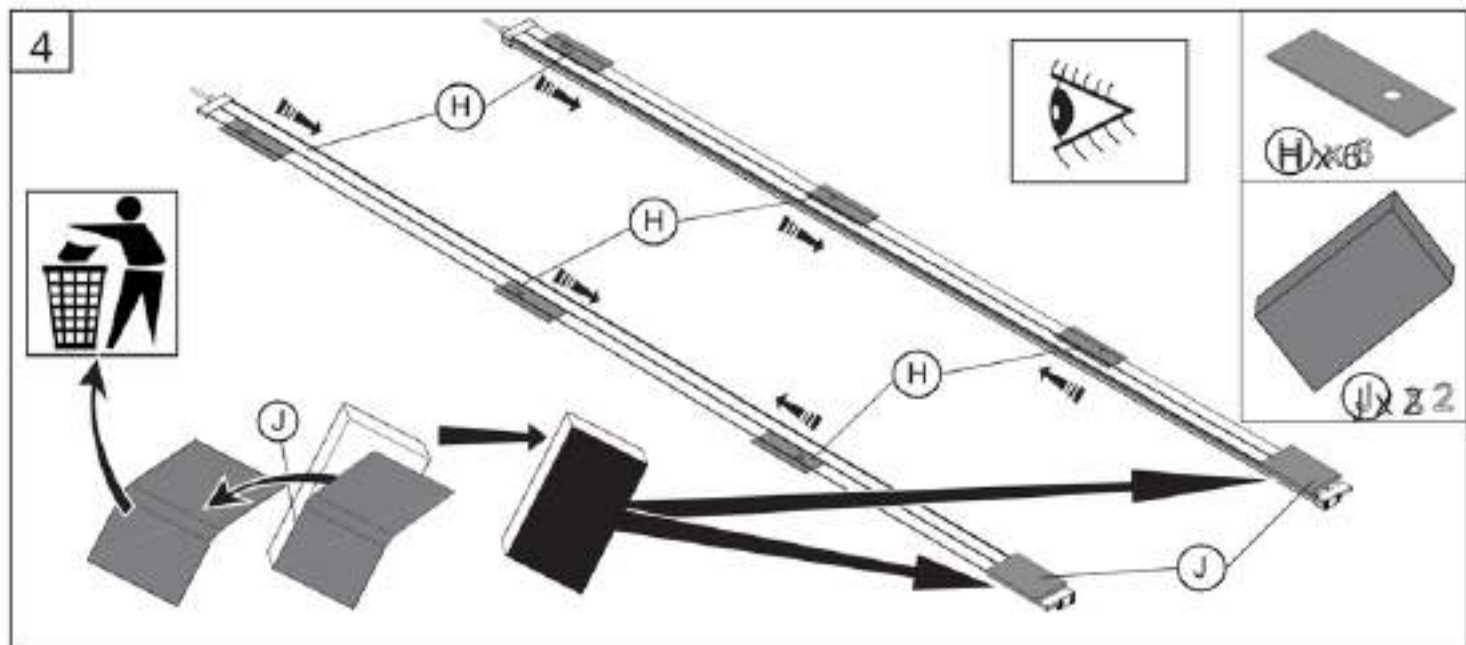

7

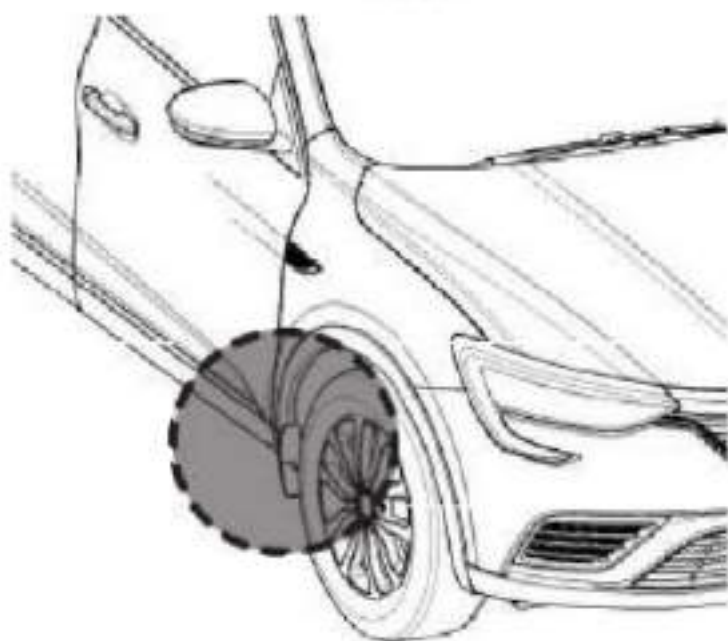
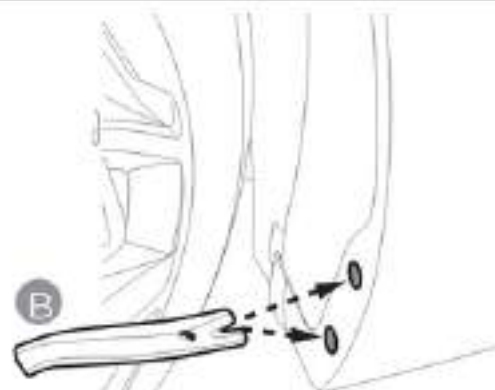
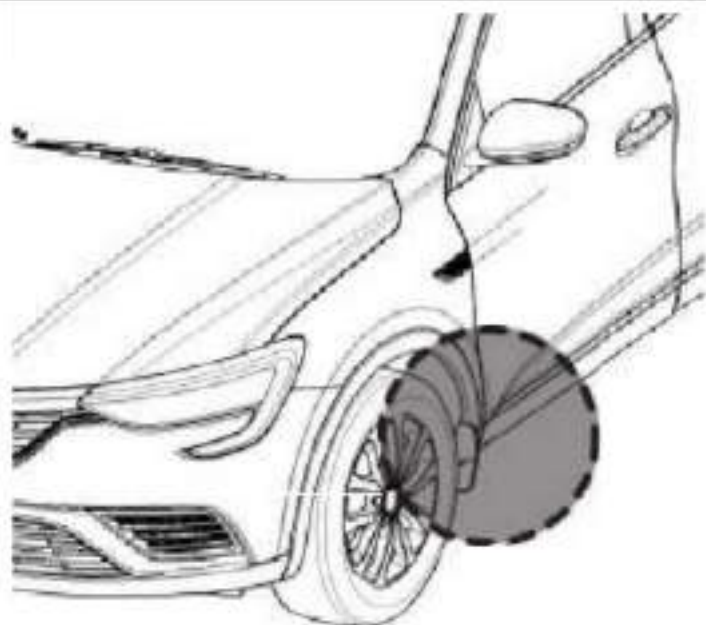

8

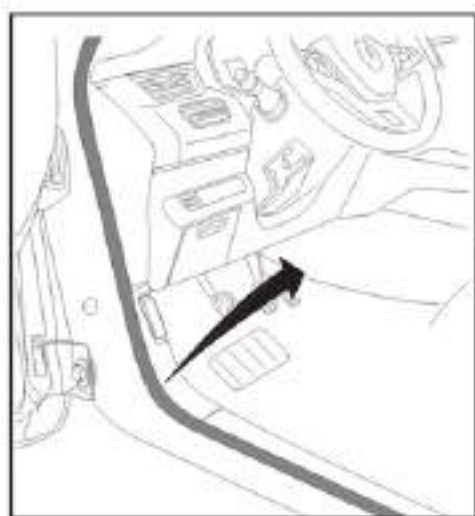

9

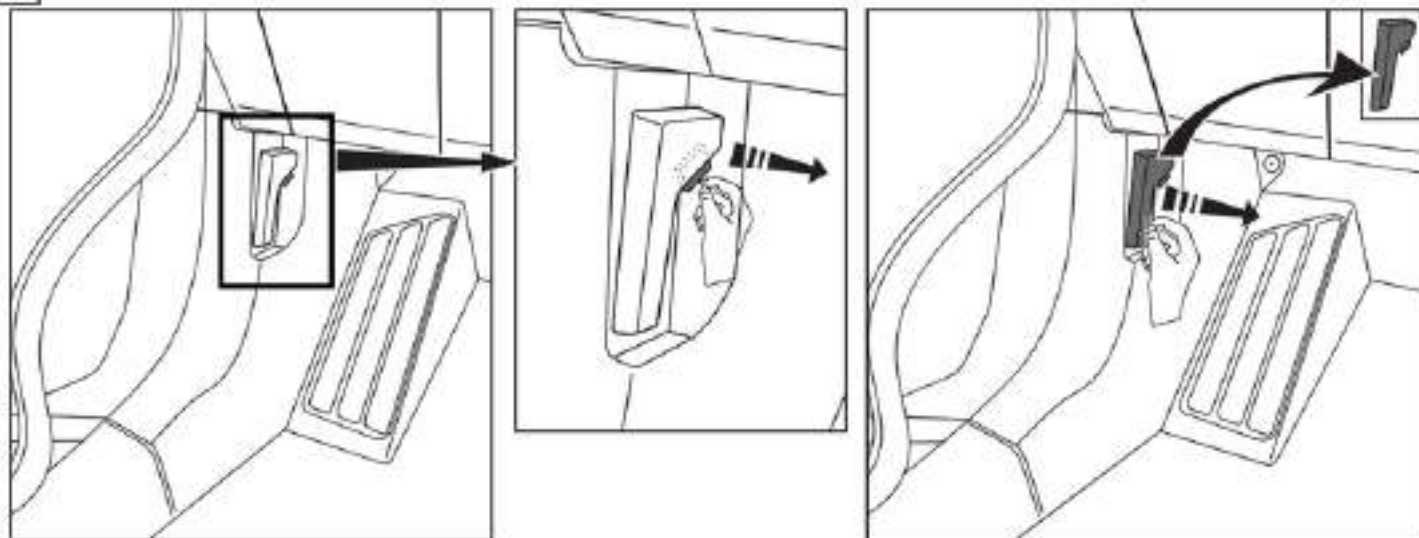

10

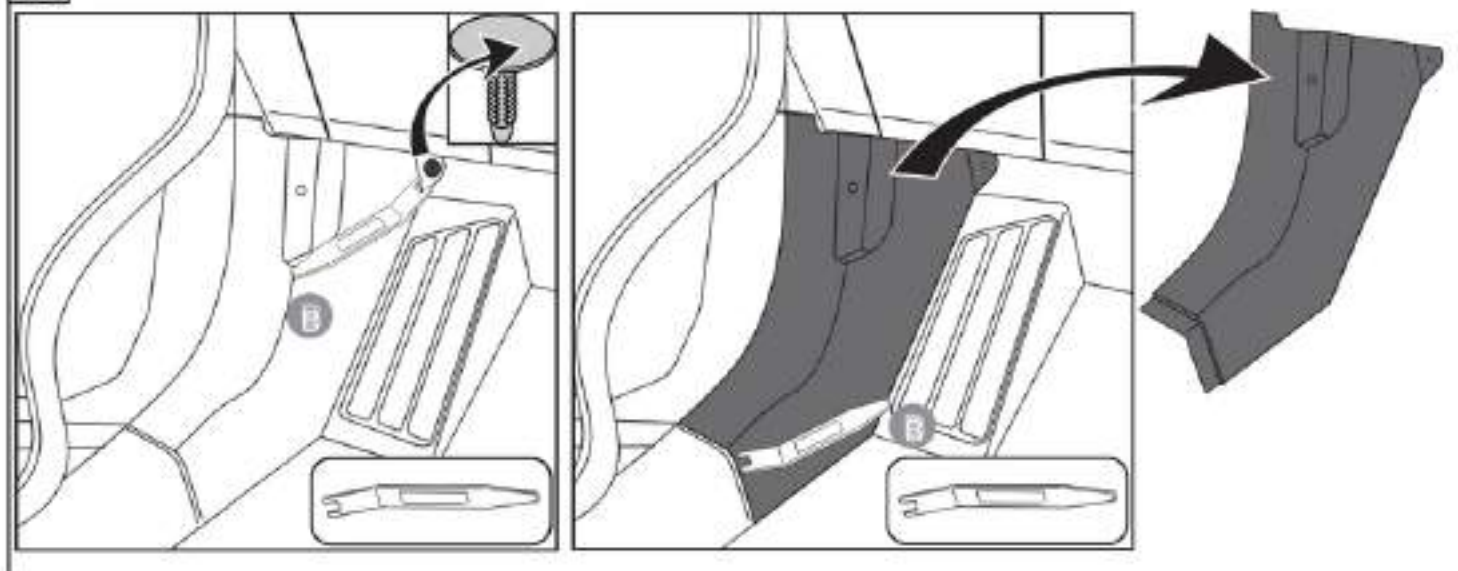

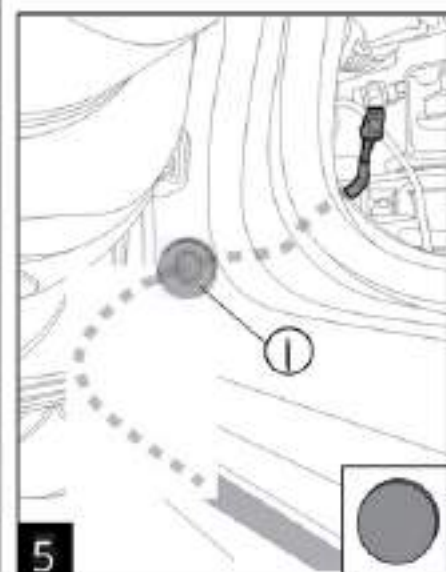
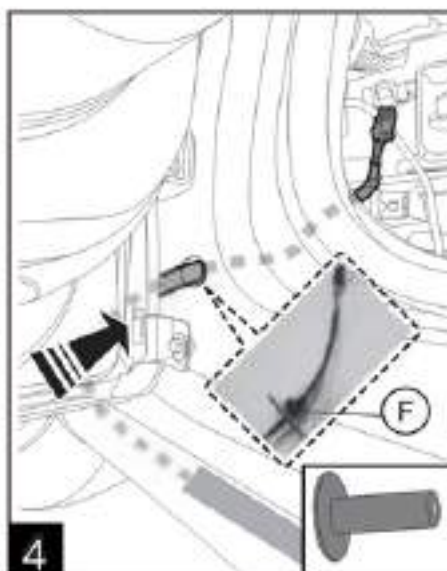
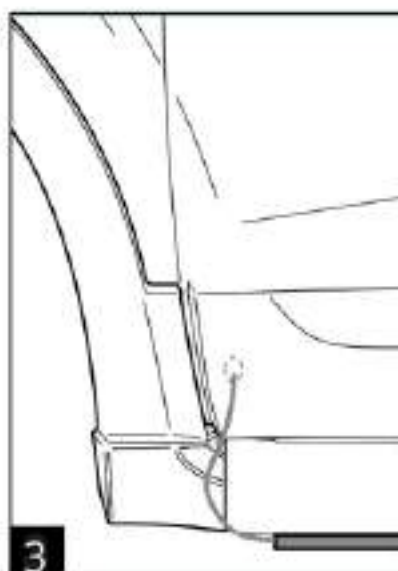
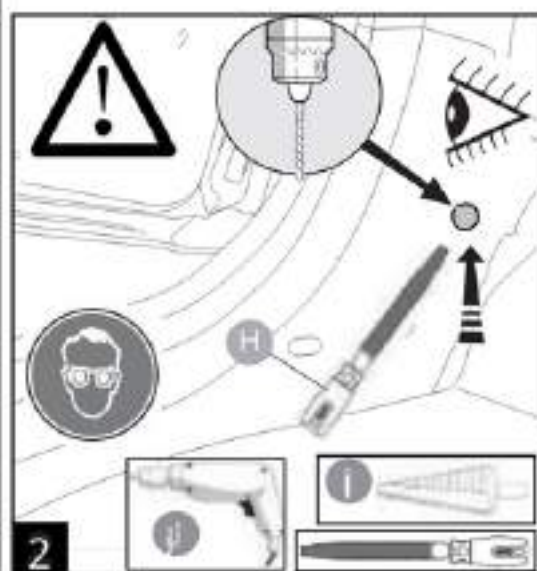
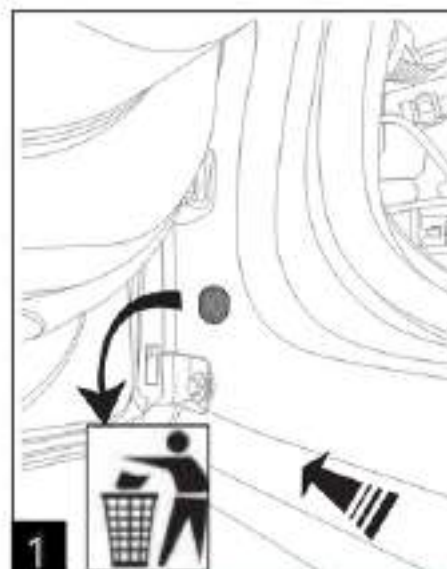
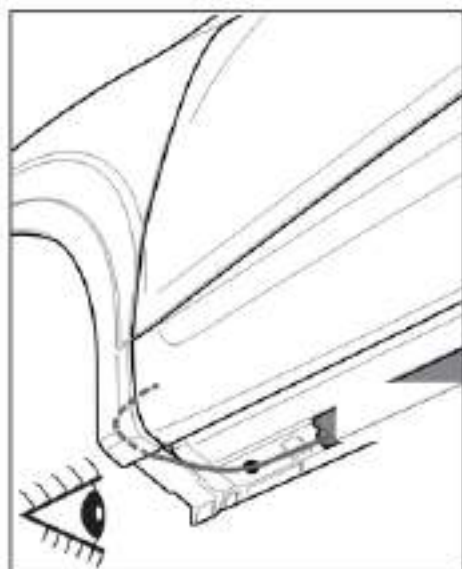

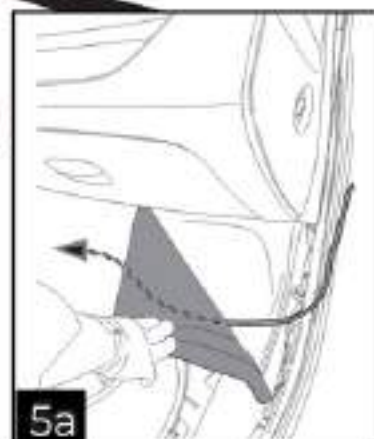
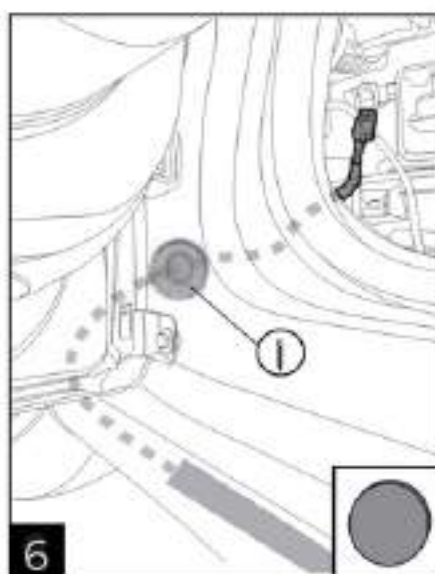
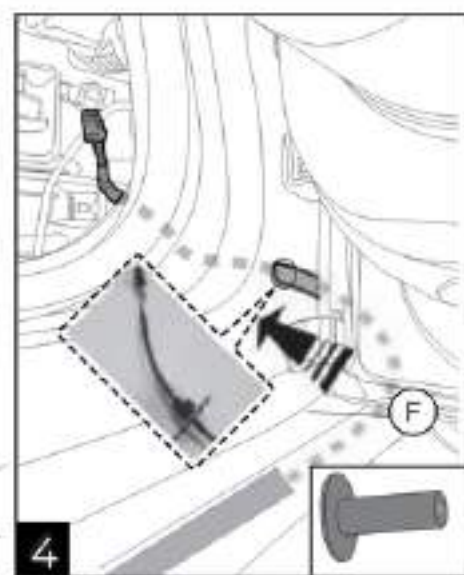
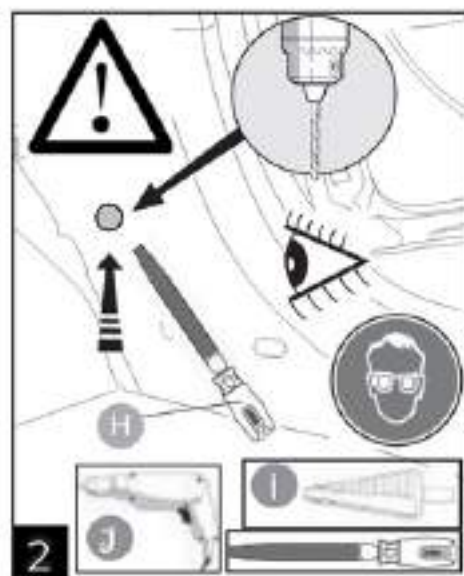
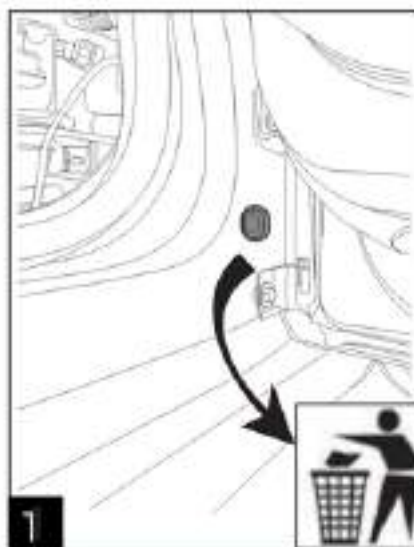
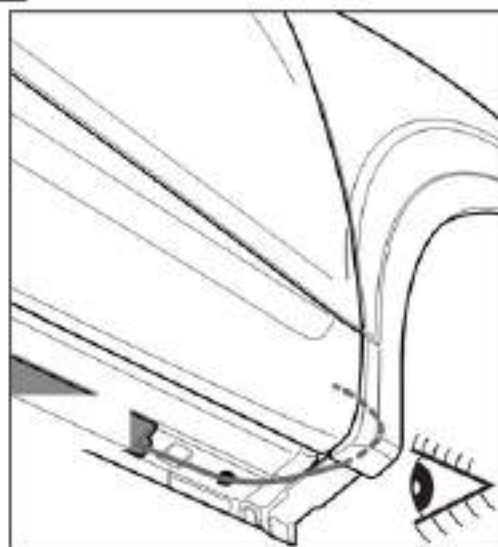



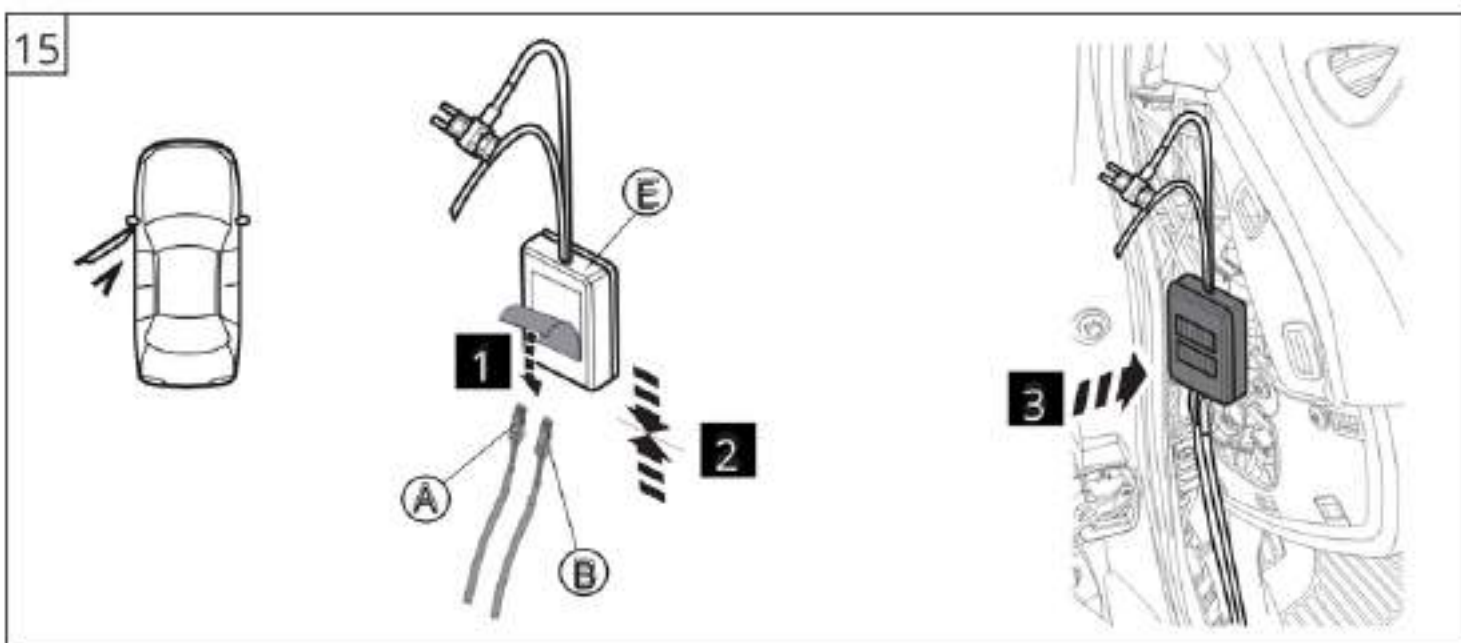
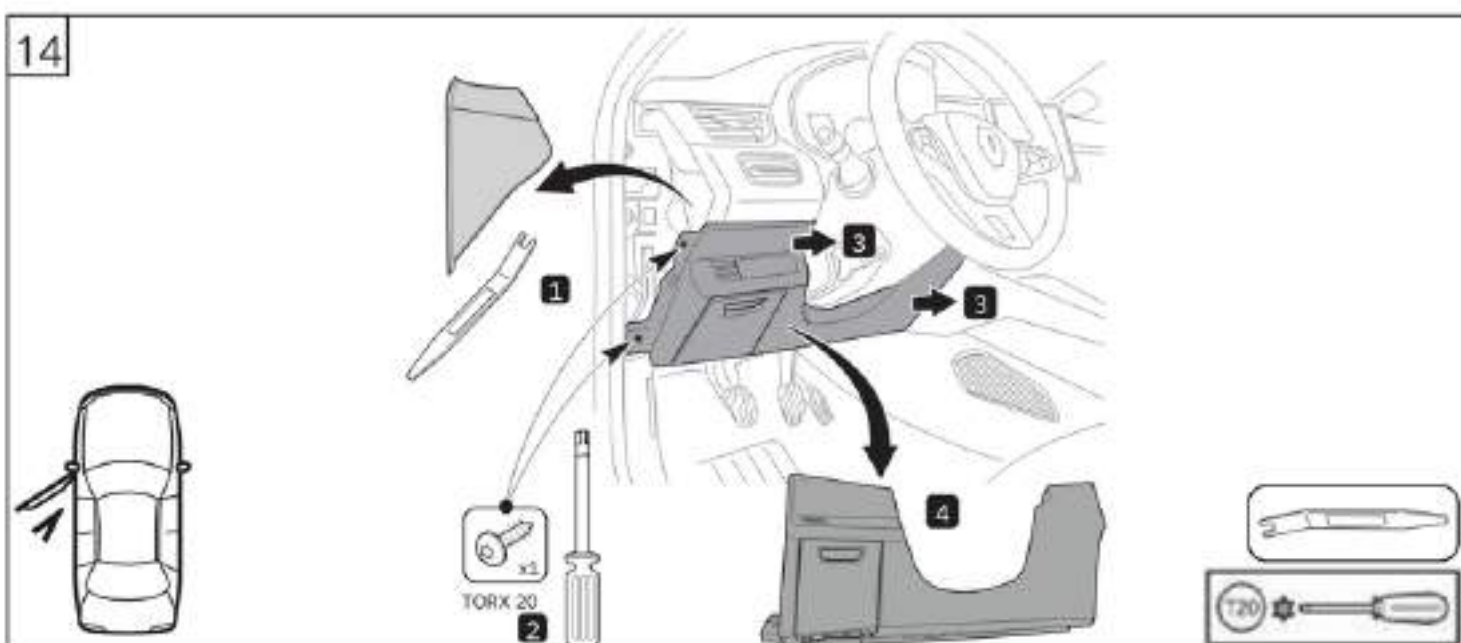
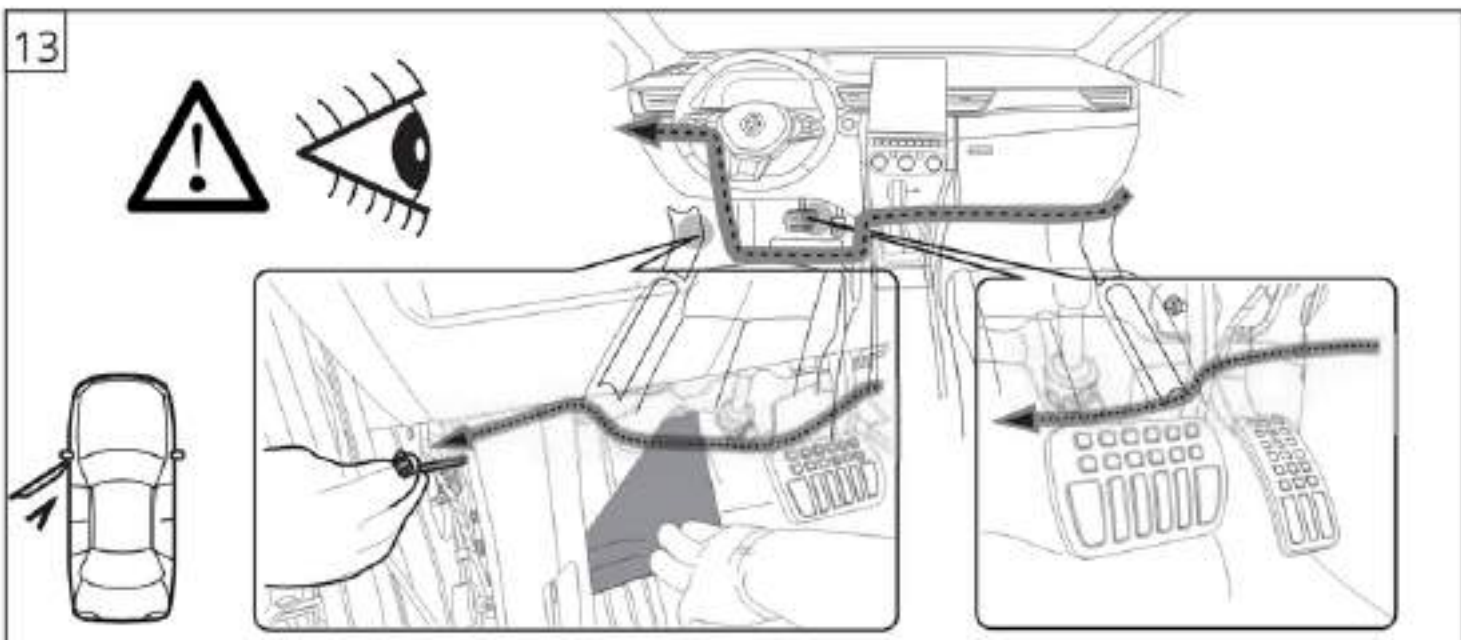

16

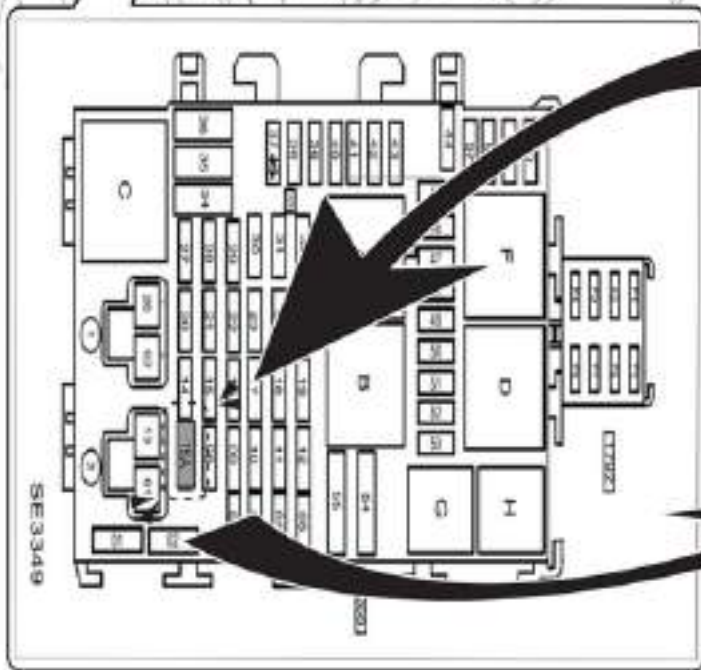

15A



bk wh gy gn rd bu ye bn pu or no

FRA	noir	blanc	gris	vert	rouge	bleu	jaune	brun	violet	or	inutilisé
CZA	czern	bijły	szary	zielony	czerven	modry	lut	hn d	fialowy	zlato	nieobszany
DAN	sort	hvid	grå	grøn	rød	blå	gul	brun	violet	guld	ikke anvendt
DEU	schwarz	weiss	grau	grün	rot	blau	gelb	braun	violett	gold	nicht belegt
ENG	black	white	grey	green	red	blue	yellow	brown	purple	gold	not occupied
ESP	negro	blanco	gris	verde	rojo	azul	amarillo	marrón	violeta	oro	no ocupado
EST	must	valge	hall	roheline	punane	sinine	kollane	pruun	purpur-punane	kuld	vaba
FIN	musta	valkoinen	harmaa	vihreä	punainen	sininen	keltainen	ruskea	violetti	kulta	ei varattu
GRK	μαύρο	λευκό	γκρίζο	πράσινο	κόκκινο	μπλε	κίτρινο	καφέ	ύβιο	χρυσό	δεν ειναι καταλαμβανόμενος
CRO	crna	bijela	siva	zelena	crvena	plava	zuta	sm e a	ljubičasta	zlato	nije određeno
HUN	fekete	fehér	szürke	zöld	piros	kék	sárga	barna	ibolyakék	arany	nem foglalt
ITA	nero	bianco	grigio	verde	rosso	blu	giallo	marrone	viola	oro	libero
JPN	黒	白	グレー	グリーン	赤	青	黄色	茶色	紫	ゴールド	予備スペース
KOR	검정	흰색	회색	초록	빨강	파랑	노랑	갈색	보라	금	없음
LTH	juoda	balta	pilka	alia	raudona	m ly na	geltona	ruda	violetinė	auksas	nedengta
LET	melns	balts	pel ks	zils	sarkans	zils	dzeltens	br ns	violeta	zelts	br vs
NLD	zwart	wit	grijs	groen	rood	blauw	geel	bruin	violet	goud	niet aangesloten
NOR	svart	hvit	grå	grønn	rød	blå	gul	brun	fiolett	gull	ikke i bruk
PLK	czarny	biały	szary	zielony	czzerwony	niebiesko	z łty	brazowy	fioletowy	łoto	wolny
PTG	preto	branco	cinzento	verde	vermelho	azul	amarelo	castanho	violeta	ouro	não ocupado
ROM	negru	alb	gri	verde	ro u	albastru	galben	maro	violet	aur	liber
RUS	чёрный	белый	серый	зеленый	красный	голубой	желтый	коричневый	фиолетовый	золото	свободно
SLK	čierna	biela	sivá	zelená	červená	modrá	lt á	hneda	violetová	zlato	nie je zadane
SLV	črna	bela	siva	zelena	rdoča	modra	rumena	rjava	vijoličasta	zlato	ni določeno
SWE	svart	vit	grå	grön	röd	blå	gul	brun	violett	guld	ej använd
TRK	siyah	beyaz	gri	ye il	kırmızı	mavi	sa n	kahverengi	mor	altın	bo

