



DUSTER



Item Code

8201474334

Artikelbezeichnung

8201480524

Référence Article

DSP/272/IX

This side bar does not interfere with the jack and its use.

Dieser Trittrohrsatz beeinträchtigt nicht die Benutzung des Wagenhebers.

Ce marchepied n'interfère pas avec le cric et son utilisation.

**1,2 h****ENG**

STAINLESS STEEL
DESIGN SIDE PROTECTION



WARNING: check the tightening of the set of bolts every 1000 km.

WARNUNG: wir schlagen vor, alle 1000 km die korrekte Festigkeit der Befestigungsbolzen zu überprüfen und ggf. nachzuziehen

















ATTENTION: controller le serrage des fixations chaque 1000 km.

D**TRITTROHR****FR**

**PROTECTION LATÉRALE
DESIGN EN ACCIER INOX**

DUSTER

8201480524

A x 8 TE 8X20 	B x 10 $\varnothing 8$  Big Grand	C x 14 $\varnothing 8$ 	D x 2 P/209/C 	E x 2 DSP/272 
F x 4 M 8 	G x 8 TE 6X25 	H x 8 $\varnothing 6$ 	I x 8 $\varnothing 6$ 	L x 8 M 6 
M x 4 $\varnothing 8$ 	N x 2 TE 8X30 	O x 2 TPS/163/B 	P x 2 DSP/272/A 	Q x 2 DSP/272/B 
R x 1 DSP/272/SX  <p>Necessary only for the four-wheel drive version on the front left side. Nötig nur für die 4-Rad-Antrieb-Variante vorne links Nécessaire seulement pour la version four-wheel drive sûr la côté avant gauche</p>				Cappellotti M8  x 8

8201474334



10
13
24



77 11 420 027
+
77 11 420 028



$\varnothing 7$ + $\varnothing 4$

DUSTER 4x2

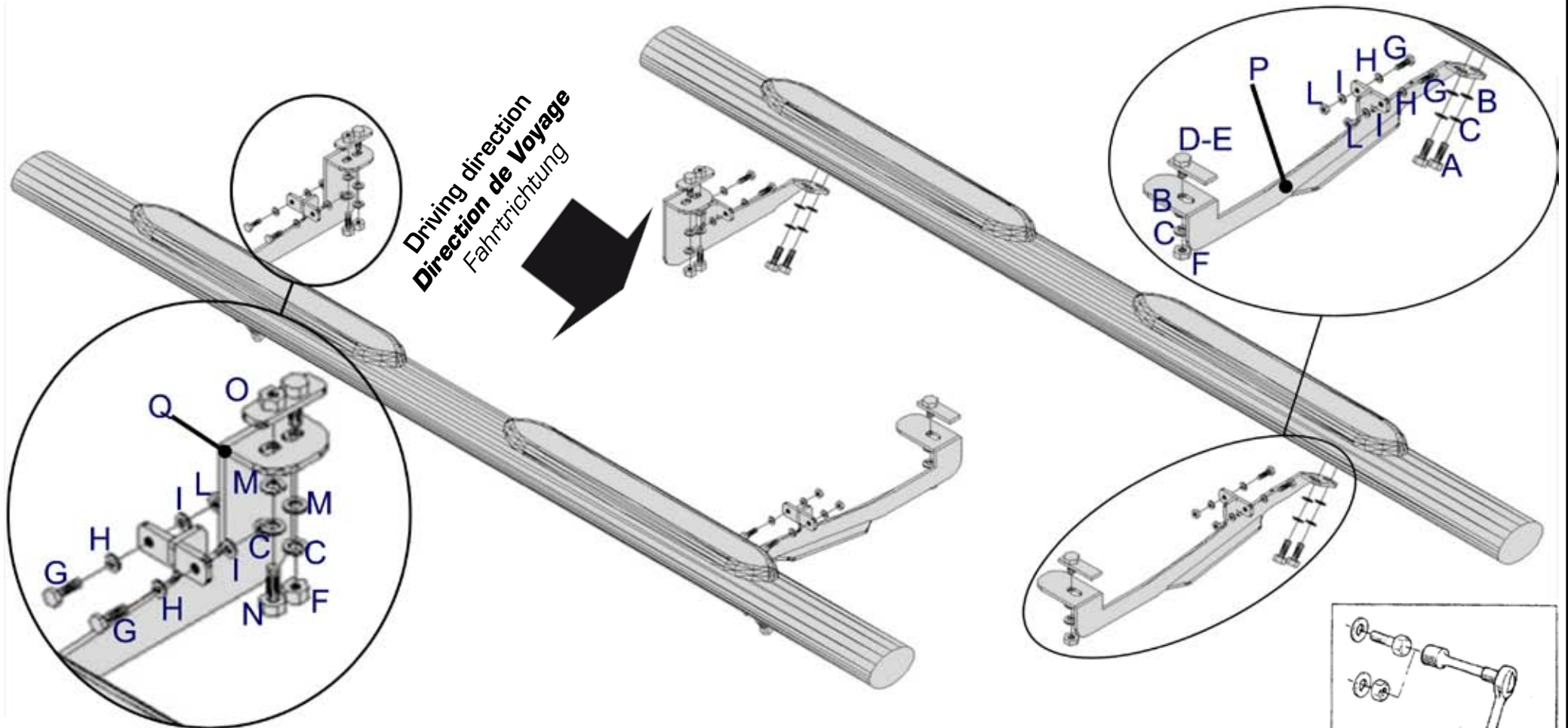

WARNING: check the tightening of the set of bolts every 1000 km.

WARNUNG: wir schlagen vor, alle 1000 km die korrekte Festigkeit der Befestigungsbolzen zu überprüfen und ggf. nachzuziehen

ATTENTION: controller le serrage des fixations chaque 1000 km.

M6: 10Nm
M8: 20Nm



DUSTER 4x4

Driving direction
 Direction de Voyage
 Fahrtrichtung

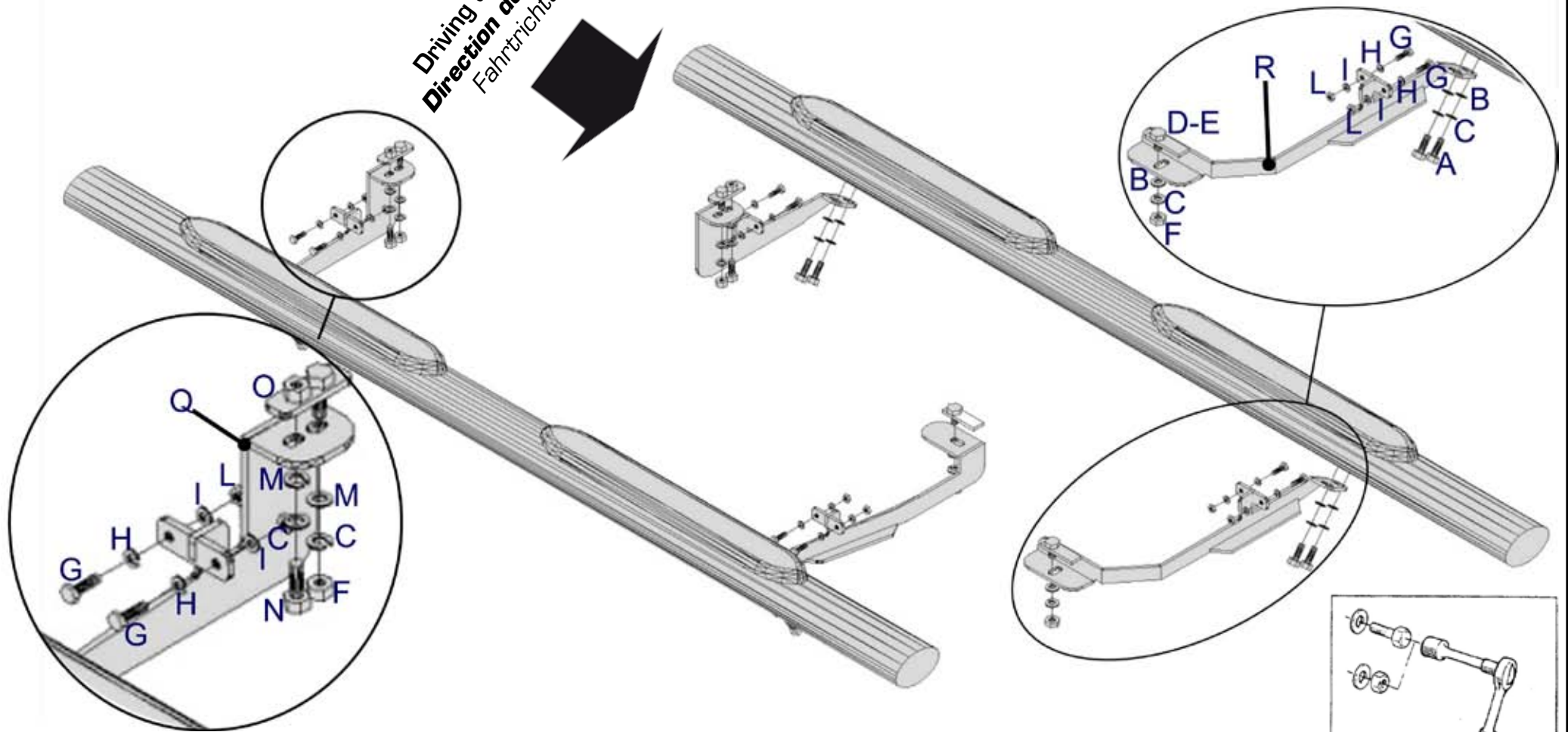

WARNING: check the tightening of the set of bolts every 1000 km.

WARNUNG: wir schlagen vor, alle 1000 km die korrekte Festigkeit der Befestigungsbolzen zu überprüfen und ggf. nachzuziehen

ATTENTION: controller le serrage des fixations chaque 1000 km.

M6: 10Nm
 M8: 20Nm

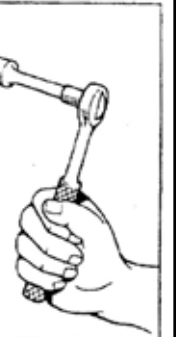

DUSTER

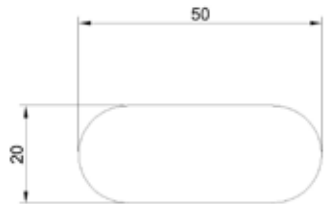

PARTICULAR E

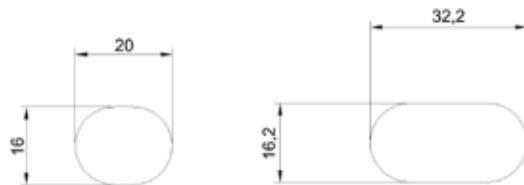
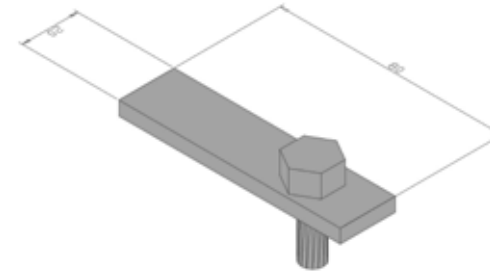

PARTICULAR D

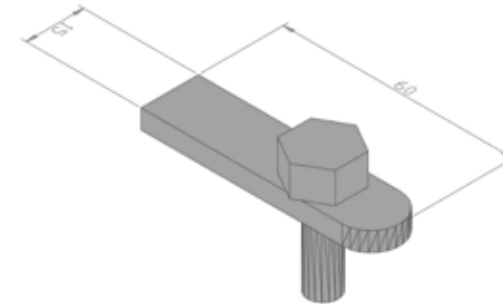



Version Ausführung Version	Parts Teilen Composants
Old - Alte - Vieux Ph1 4x2 Old - Alte - Vieux Ph1 4x4	Ex2 D+E
New - Neu - Nouveau Ph1 4x2 New - Neu - Nouveau Ph1 4x4	Dx2 Dx2
Ph2 4x2	Dx2
Ph2 4x4	Dx2

This product must only be used with the vehicles mentioned at the top of the first page of the assembly and/or user manual.

Dieses Produkt darf nur an Fahrzeugen verbaut werden, die auf der ersten Seite der Anbauanleitung/ Gebrauchsanweisung in der Auflistung oben aufgeführt sind.

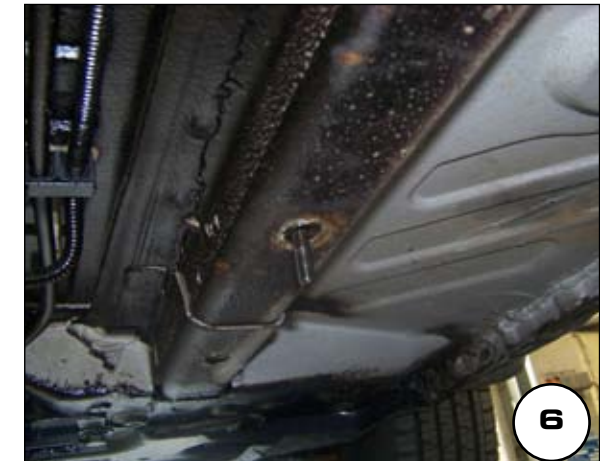
Ce produit ne doit pas être utilisé sur d'autres véhicules que ceux spécifiés en haut de la première page de la notice de montage et/ou d'utilisation.





Date Datum Date	Item Code Artikelbezeichnung Réf. Article	Vehicle model Fahrzeugmodell Modèle de Voiture
25/03/15	8201474334 8201480524 (DSP/272/IX)	  DUSTER



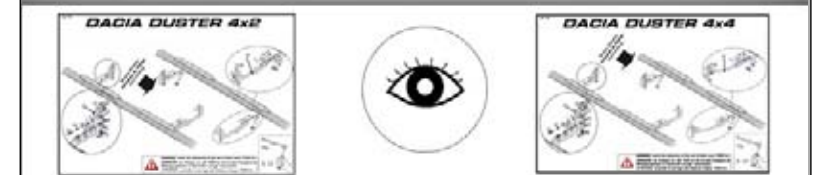

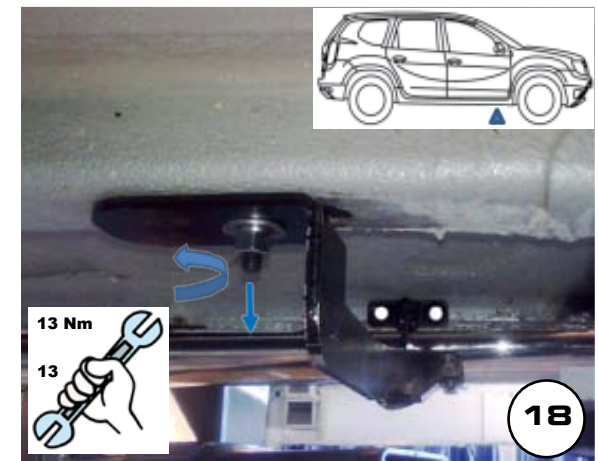
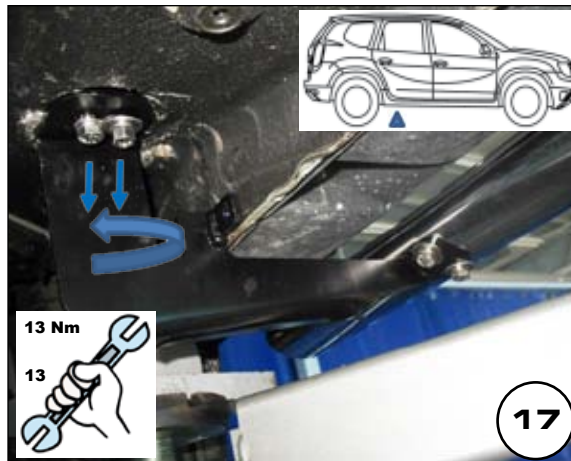
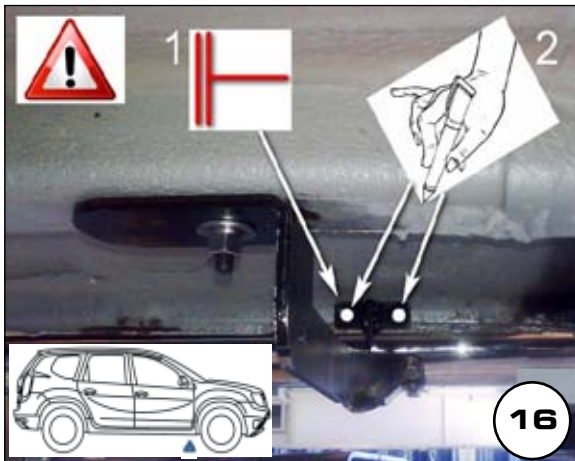
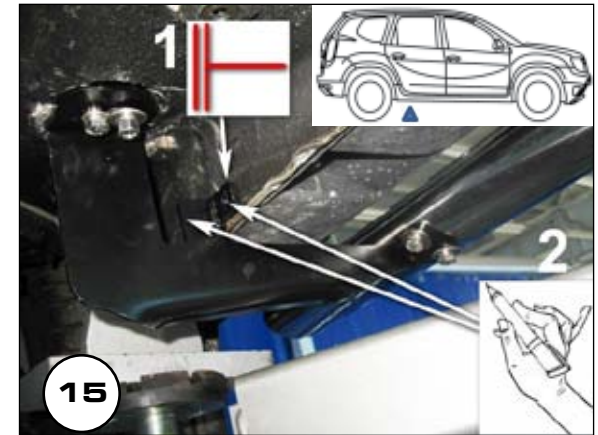
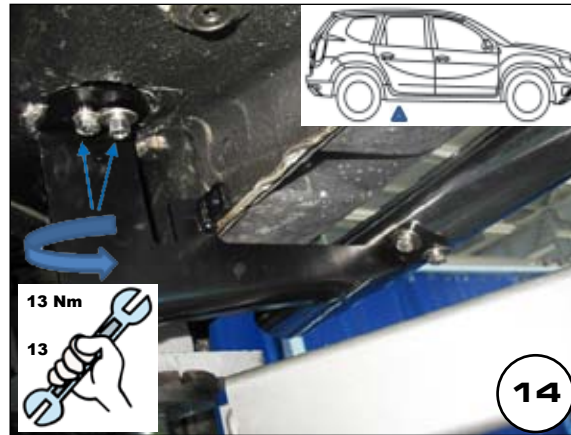
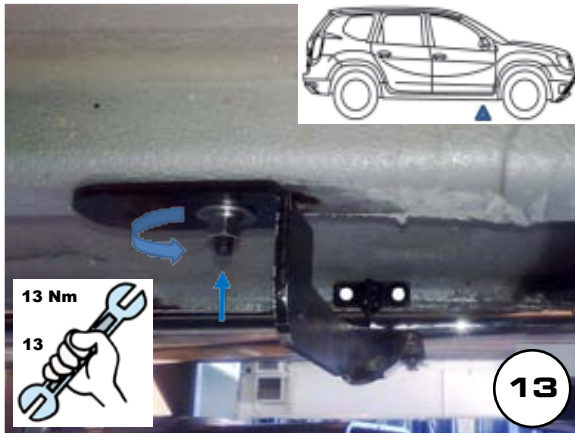
Date Datum Date	Item Code Artikelbezeichnung Réf. Article	Vehicle model Fahrzeugmodell Modèle de Voiture
25/03/15	8201474334 8201480524 (DSP/272/IX)	  DUSTER





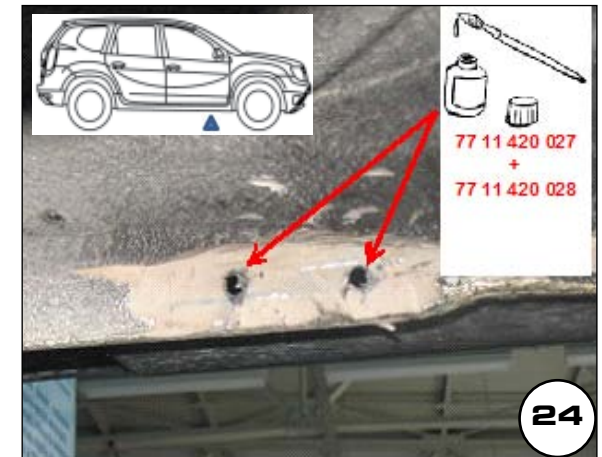
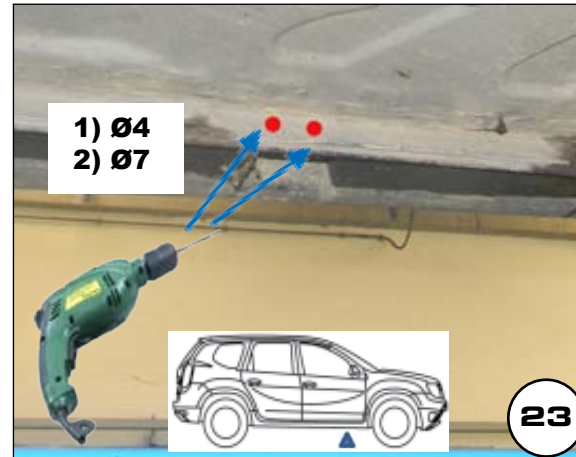
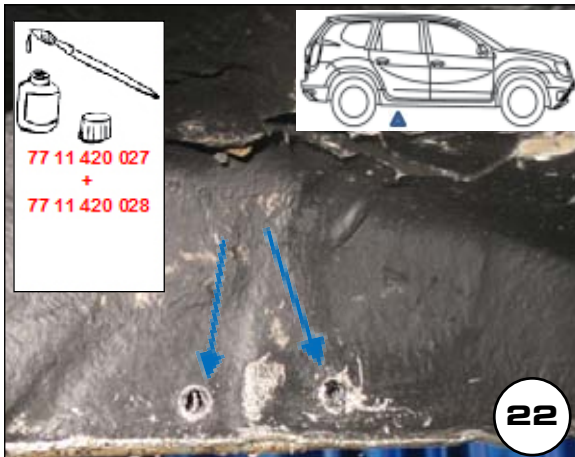
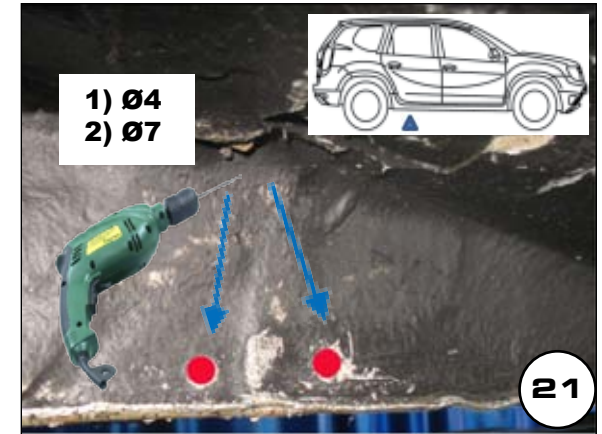
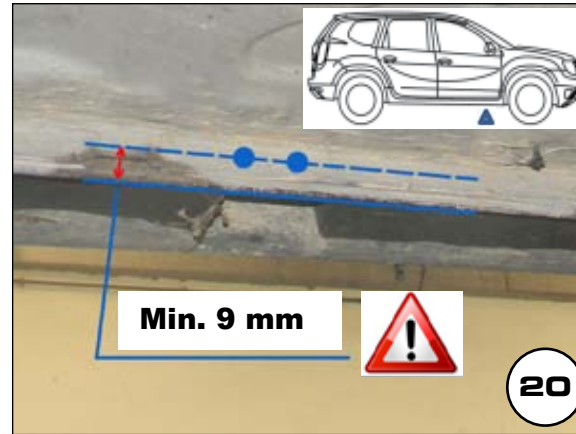
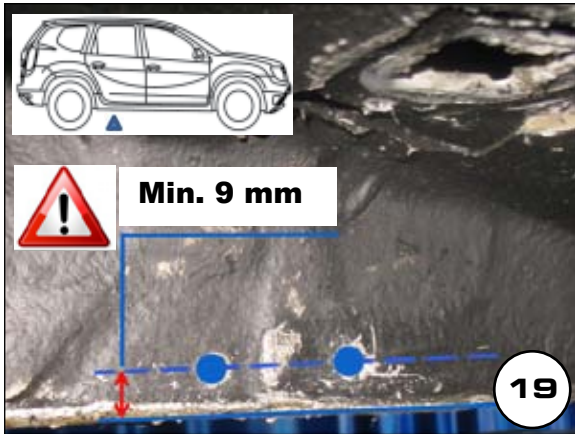

Date Datum Date	Item Code Artikelbezeichnung Réf. Article	Vehicle model Fahrzeugmodell Modèle de Voiture
<p>25/03/15</p>	<p>8201474334 8201480524 (DSP/272/IX)</p>	  <p>DUSTER</p>



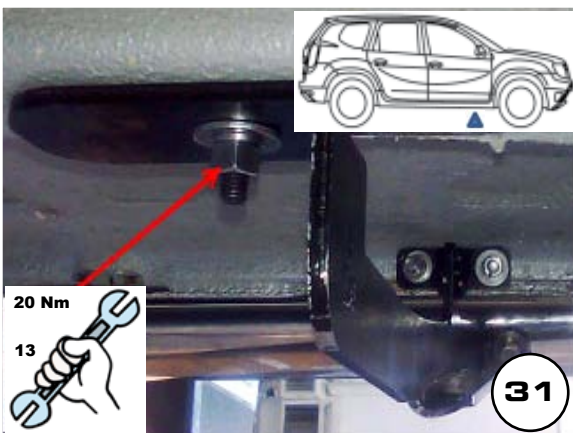
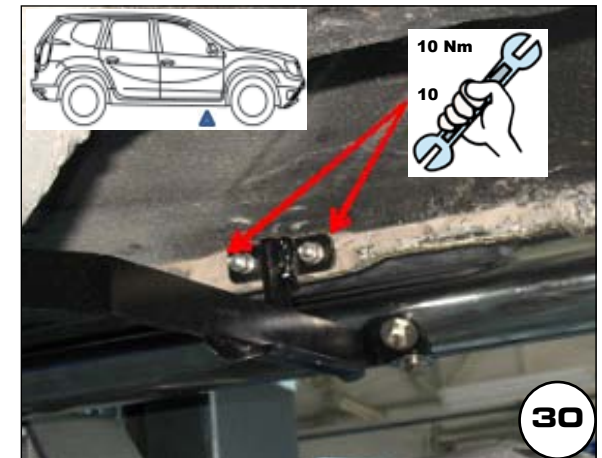
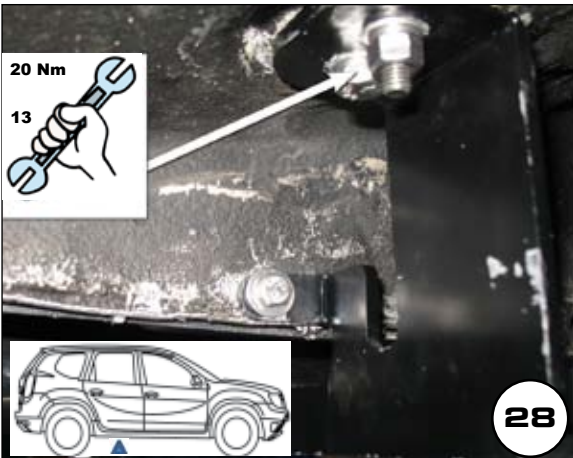
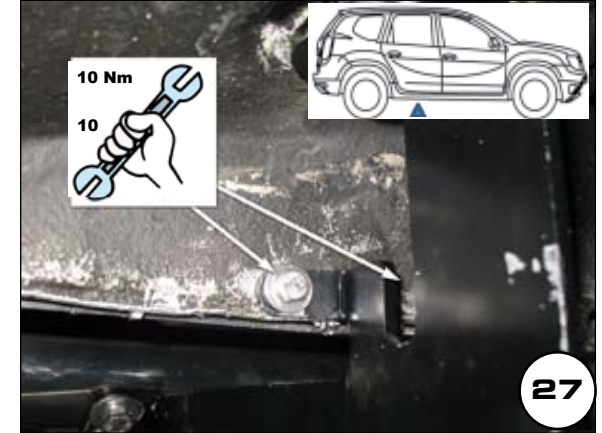
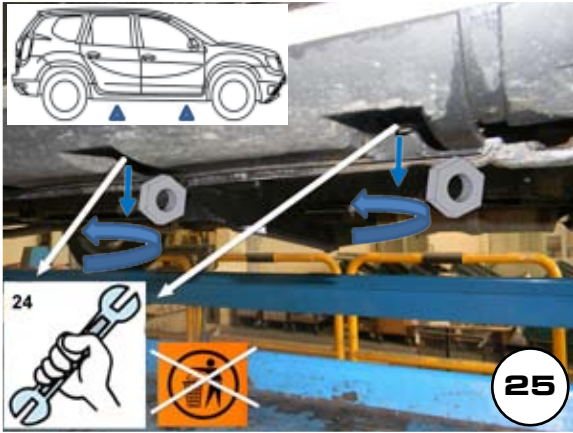

Date <i>Datum</i> <i>Date</i>	Item Code <i>Artikelbezeichnung</i> <i>Réf. Article</i>	Vehicle model <i>Fahrzeugmodell</i> <i>Modèle de Voiture</i>
25/03/15	8201474334 8201480524 (DSP/272/IX)	  DUSTER



Date Datum Date	Item Code Artikelbezeichnung Réf. Article	Vehicle model Fahrzeugmodell Modèle de Voiture
25/03/15	8201474334 8201480524 (DSP/272/IX)	  DUSTER

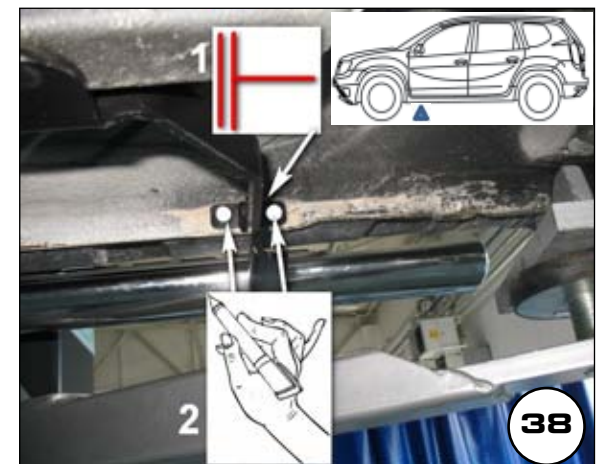
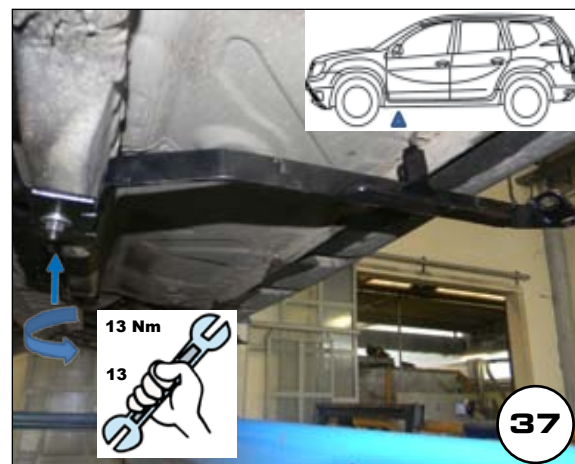

FRONT LEFT 4x4 - VORDER LINKS 4X4 - AVANT GAUCHE 4X4

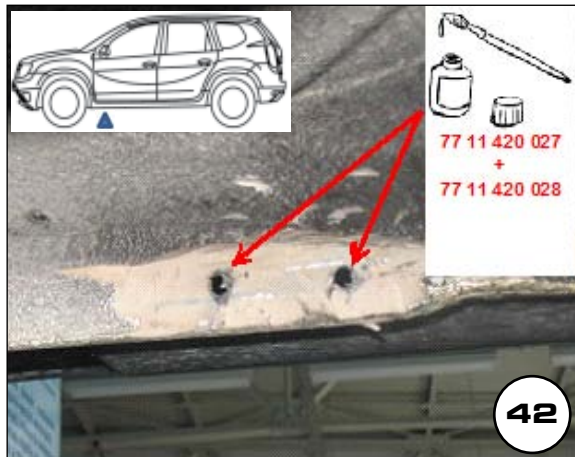
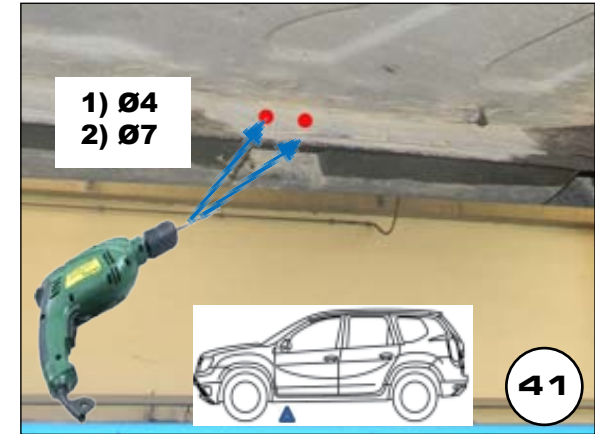
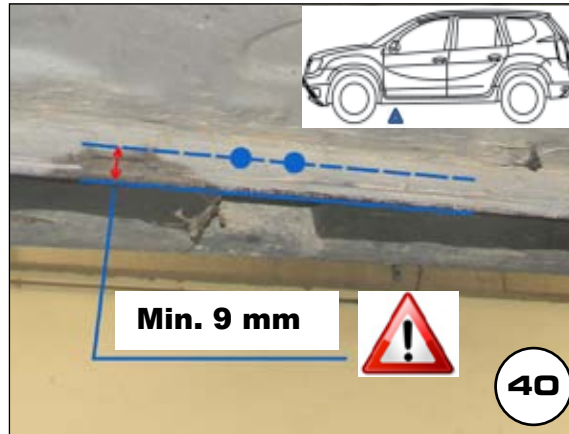
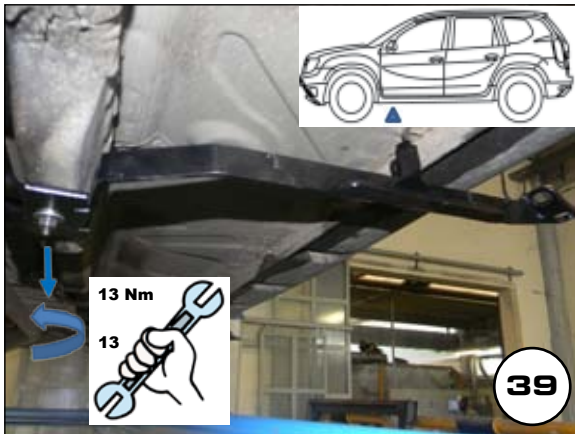

Date Datum Date	Item Code Artikelbezeichnung Réf. Article	Vehicle model Fahrzeugmodell Modèle de Voiture
25/03/15	8201474334 8201480524 (DSP/272/IX)	  DUSTER

FRONT LEFT 4x4 - VORDER LINKS 4X4 - AVANT GAUCHE 4X4



Date Datum Date	Item Code Artikelbezeichnung Réf. Article	Vehicle model Fahrzeugmodell Modèle de Voiture
25/03/15	8201474334 8201480524 (DSP/272/IX)	  DUSTER

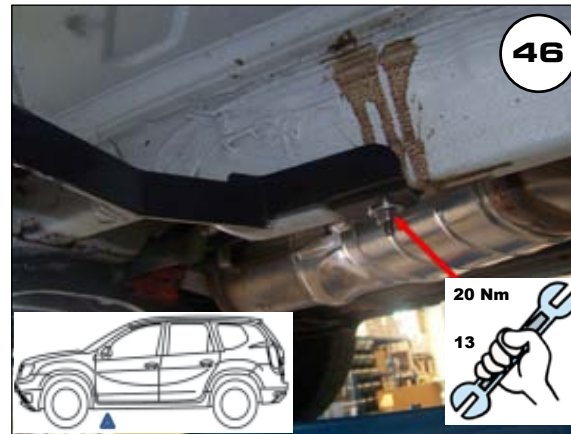

FRONT LEFT 4x4 - VORDER LINKS 4X4 - AVANT GAUCHE 4X4



WARNING: the warranty is not valid unless the fitting follows exactly the instructions given in this document.

Warnung: die Garantie erlischt, wenn nicht exakt den Montageanweisungen in diesem Dokument gefolgt wird!

ATTENTION: la garantie n'est pas valable si l'assemblage ne suit pas les directions donnés dans cette notice d'installation.

Date Datum Date	Item Code Artikelbezeichnung Réf. Article	Vehicle model Fahrzeugmodell Modèle de Voiture
25/03/15	8201474334 8201480524 (DSP/272/IX)	  DUSTER

Stainless Steel – material and maintenance

The material used is AISI 304 stainless steel, which is a material resistant to corrosion without any need of further treatments or surface protections. Despite every care in processing we cannot avoid that the welded seams are particularly at risk due to surface tensions of the material in this area and through external damaging. Regular maintenance, however, lessens the risk of damages like blind spots can result - in extreme cases even rust formation on the surface. Therefore we ask you to use soap and water to keep the accessory clean or a soft, non acid or corrosive cleaning product specific stainless steel. We expressly point out that our guarantee only applies if this maintenance was demonstrably carried out!

Edelstahl - Material und Pflege

Das verwendete Material ist AISI 304 Edelstahl, das korrosionsresistent ist und keine weitere Oberflächenbehandlung oder -schutz benötigt. Trotz aller Sorgfalt bei der Verarbeitung ist es nicht zu vermeiden, dass die Schweißnähte wegen der Oberflächenspannungen des Materials in diesem Bereich und durch äußere Beschädigungen besonders gefährdet sind. Eine regelmäßige Pflege vermindert jedoch das Risiko von Schäden wie blinde Stellen, in Extremfällen sogar Rostbildung an der Oberfläche können durch eine regelmäßige Pflege vermindert werden. Deshalb verwenden Sie bitte Seife und Wasser zur Reinigung oder ein sanftes, nicht säurehaltiges oder nicht korrosionsverursachendes Reinigungsprodukt speziell für Edelstahl, um die Anbauteile zu pflegen. Wir weisen ausdrücklich darauf hin, dass unsere Gewährleistung nur dann greift, wenn diese Pflege nachweislich durchgeführt wurde !

Acier fin – Matériel et entretien

Le matériel utilisé est acier inox AISI 304 qui est naturellement résistant à la corrosion sans nécessiter aucun traitement ou protection superficielle. Malgré toute la diligence dans le façonnage il est inévitable que les lignes de soudure, à cause des tensions superficielles du matériel dans cette zone et à travers dommages extérieurs, soient particulièrement exposées au danger. Un entretien régulier réduit pourtant sensiblement le danger de dommages comme taches opaques et en cas extrêmes même création de rouille sur la surface.

Nous Vous demandons donc d'utiliser eau et savon pour nettoyer l'accessoire ou des produits légers, non acides ou corrosives spécifiques pour acier inox. Nous indiquons expressément que notre garantie s'applique seulement si cet entretien est exécuté de manière démontrable !

Anodized aluminum – material and maintenance

Through the anodic coating the aluminum is covered with a layer of aluminum oxide which protects the material. The cleaning of the anodized surfaces must be done using products with neutral PH, such as water and soap or products specific for aluminum.

Do not use alkaline, acid or abrasive products which may damage the aluminum surface. We expressly point out that our guarantee only applies if this maintenance was demonstrably carried out!

Eloxiertes Aluminium – Material und Pflege

Durch die Eloxierung ist das Aluminium mit einer Oxidschicht beaufschlagt, die das Material beschützt. Das Reinigen von eloxierten Oberflächen muß mit PH- neutralen Produkten, wie Wasser und Seife oder einem speziellen Aluminiumpflegeprodukt ausgeführt werden. Keine basischen, säurehaltigen, oder abrasive Reinigungsprodukte verwenden, da sie die Aluminiumoberfläche beschädigen können. Wir weisen ausdrücklich darauf hin, daß unsere Garantie nur gültig ist, wenn die ordnungsgemäße Pflege nachweislich ausgeführt wurde.

Aluminium anodisé – Matériel et entretien

A travers l'anodisation l'aluminium est couvert par une couche d'oxyde d'aluminium qui protège le matériel.

Le nettoyage des surfaces anodisées doit être fait en utilisant des produits avec PH neutre comme eau et savon ou des produits spécifiques pour aluminium.

Ne pas utiliser des produits alcalines, acides ou abrasives qui puissent endommager la surface de l'aluminium. Nous indiquons expressément que notre garantie s'applique seulement si cet entretien est exécuté de manière démontrable !

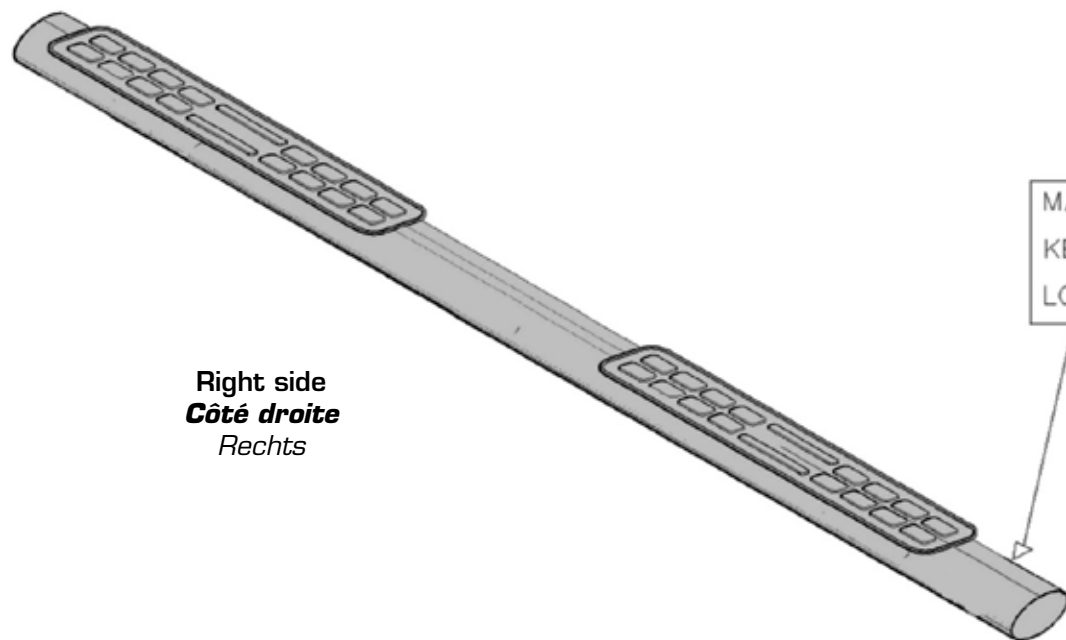

Right side
Côté droite
Rechts

MACH s.r.l.
KBA ***** Type s272
LOT **/****



KBA Approval Certificate
KBA Homologationsdokument
Certifié d'homologation KBA