

Max **120** Km/h

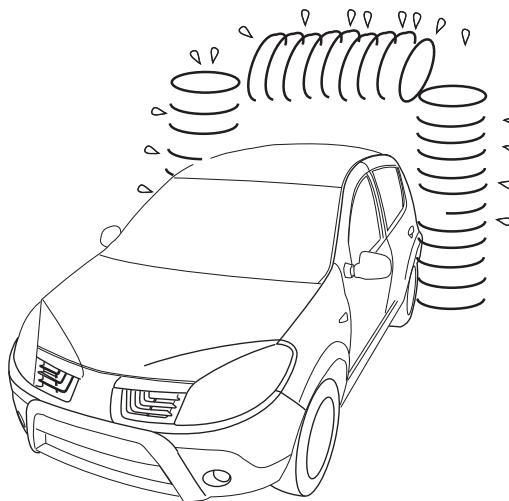

BARRES LOGAN 2 & SANDERO 2

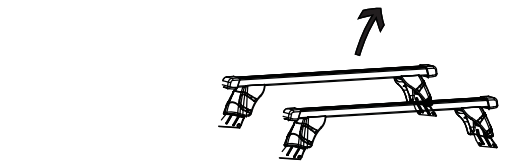
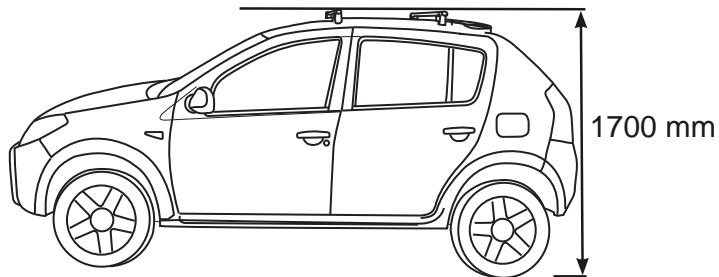
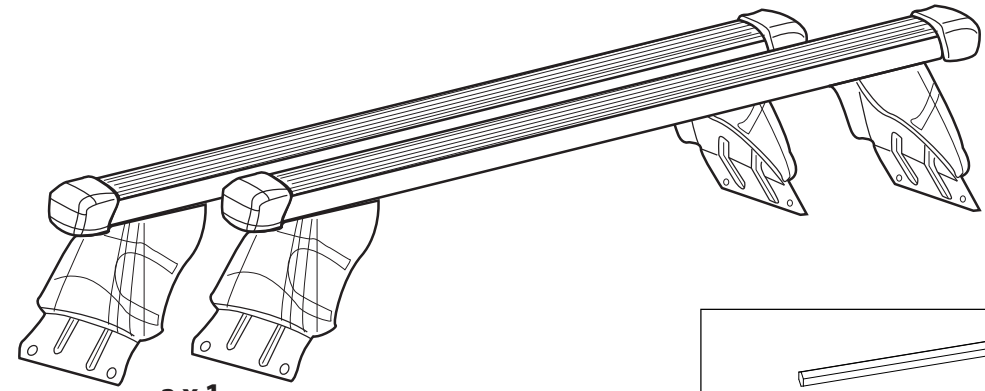

a x 1

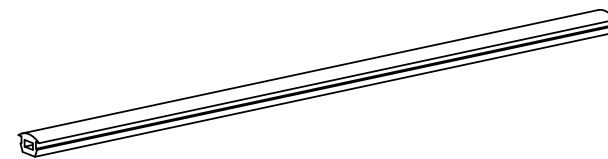

e x 1

d x 1

S56

b x 8  Ø6 x 20

c x 8  Ø6

 = Max. 75 kg

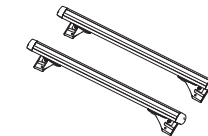
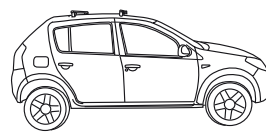

 = 4 kg

1200 mm

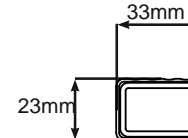

Réf. Imp.: 057668/B12-1

Mont Blanc France

24-30 Rue Claude Bernard - C.S. 61768

35417 Saint Malo Cédex - France

Office : +33 (0)2 99 21 12 70

Fax : +33 (0)2 99 21 12 71

www.montblancgroup.com

- FR Garder cette notice pour les utilisations futures.
- EN Keep these instructions for future use.
- DE Die Anleitung zur späteren Benutzung aufbewahren.
- IT Conservare queste istruzioni per ogni ulteriore consultazione.
- ES Guardar este manual para futuras utilizations.
- PL Zachować instrukcję w przypadku użytkowania w przyszłości.
- NL Bewaar deze gebruiksaanwijzing voor toekomstige raadpleging.
- PT Guardar este manual para as utilizações futuras.
- HU Őrizze meg ezt a használati utasítást későbbi felhasználás céljából.
- RU Сохраните эту инструкцию для дальнейшего пользования.
- GR Φυλάξτε αυτό το εγχειρίδιο οδηγιών για μελλοντικές χρήσεις.
- DK Gem denne vejledning til senere brug.
- CZ Uchovejte návod pro pozdější použití.
- RO Păstrați instrucțiunile pentru consultarea lor ulterioară.
- LT Saglabājiet šo instrukciju turpmākai lietošanai.
- LV Saugokite šī instrukcija, kad ateitjye galētumēte ja pasinaudoti.
- EE Hoidke need juhised edaspidiseks kasutuseks alles.
- SK Tento návod si uchovajte pre ďalšie použitie.
- SI Sačuvajte ovaj priručnik za buduću upotrebu.
- HR Čuvati ove upute za daljnju uporabu.
- RS Čuvajte instrukcije za dalju upotrebu .

